



ORIENT

Photo coupler

Product Data Sheet

Part Number: OR-H11LX-(GK)

Customer: _____

Date: _____

SHENZHEN ORIENT COMPONENTS CO.,LTD.

Block A 3rd Floor No.4 Building,Tian'an Cyber Park,Huangge Rd,LongGang Dist,Shenzhen,GD

TEL: 0755-29681816

FAX: 0755-29681200

www.orient-opto.com

1. Features

- (1) High data rate, 1MHz typical (NRZ)
- (2) Free from latch up and oscillation throughout voltage and temperature ranges.
- (3) Microprocessor compatible drive
- (4) Logic compatible output sinks 16mA at 0.6V maximum
- (5) Guaranteed on/off threshold hysteresis
- (6) Open drain output.
- (7) Wide operating range
- (8) Guaranteed performance over temperature $-40^{\circ}\text{C} \sim +85^{\circ}\text{C}$.
- (9) Safety approval
 - UL approved (No.E323844)
 - VDE approved(No.40029733)
 - CQC approved (No.CQC19001231480)
- (10) In compliance with RoHS, REACH standards
- (11) MSL Level 1

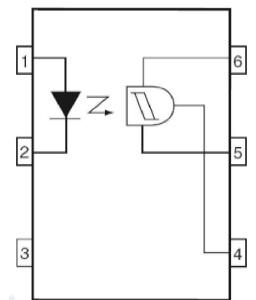

- Pin Configuration**
1. Anode
 2. Cathode
 3. No Connection
 4. V_O
 5. GND
 6. V_{CC}

2. Instructions

The OR-H11LX-(GK) series of devices each consist of a GaAs infrared emitting diode optically coupled a high speed integrated circuit detector. The output detector incorporates a Schmitt trigger, which provides hysteresis for noise immunity and pulse shaping. The devices are in a 6-pin DIP package and available in wide-lead spacing and SMD option.

3. Application Range

- (1) Logic to logic isolator
- (2) Programmable current level sensor
- (3) Line receiver—eliminate noise and transient problems
- (4) A.C. to TTL conversion—square wave shaping
- (5) Digital programming of power supplies
- (6) Interfaces computers with peripherals

4. Max Absolute rated Value (Normal Temperature=25°C)

Parameter		Symbol	Rated Value	Unit
Input	Forward Current	I_F	60	mA
	Reverse Voltage	V_R	6	V
	Power dissipation (T A = 25°C) Derating factor (above 100°C)	P	120	mW
Output	V45 Allowed Range	V_O	0-16	V
	V65 Allowed Range	V_{CC}	3-16	V
	I 4 Output Current	I_O	50	mA
	Power Dissipation	P	150	mW
*1 Isolation Voltage		V_{ISO}	5000	°C
Operating Temperature		T_{OPR}	-40 to + 85	
Storage Temperature		T_{STG}	-55 to + 150	
*2 Soldering Temperature		T_{SOL}	260	

*1. AC Test, 1 minute, humidity = 40~60%
 Insulation test method as below:
 (1) Short circuit both terminals of photocoupler.
 (2) No Current when testing insulation voltage.
 (3) Adding sine wave voltage when testing.

*2. soldering time is 10 seconds.

5. Opto-electronic Characteristics

Parameter		Symbol	Min	Typ.*	Max	Unit	Condition	
Input	Forward Voltage	V_F	1.0	1.2	1.6	V	$I_F=10\text{mA}$	
			0.75	---	---		$I_F=0.3\text{mA}$	
	Reverse Current	I_R	---	---	10	μA	$V_R=3\text{V}$	
	Collector capacitance	C_{in}	---	---	100	pF	$V=0, f=1\text{MHz}$	
Output	Operating Voltage Range		V_{CC}	3	---	15	V	
	Supply Current		$I_{CC(off)}$	---	1.9	5.0	mA	$I_F=0$ $V_{CC}=5\text{V}$
	Output Current, High		I_{OH}	---	---	100	μA	$I_F=0$ $V_{CC}=V_O=15\text{V}$
	Supply Current		$I_{CC(on)}$	---	2.5	5.0	mA	$I_F=10\text{mA}$ $V_{CC}=5\text{V}$
	Output Voltage, low		V_{OL}	---	0.2	0.4	V	$R_L=270\Omega$ $V_{CC}=5\text{V}$ $I_F=I_F(on)_{max}$
	Turn-On Threshold Current ⁽¹⁾	H11L1	$I_{F(ON)}$	---	---	1.6	mA	$R_L=270\Omega$ $V_{CC}=5\text{V}$
		H11L2		---	---	10.0		
		H11L3		---	---	5.0		
Turn-On Threshold Current		$I_{F(OFF)}$	0.3	1.0	---	mA		
Hysteresis Ratio		$I_{F(OFF)}/I_{F(ON)}$	0.5	0.75	0.90	mA		

Note:

1. Maximum $I_{F(ON)}$ is the maximum current required to trigger the output, For example, a 2mA maximum trigger current would require the LED to be driven at a current greater than 2mA to guarantee the device turns on. A 10% guard band is recommended to account for degradation of LED over its lifetime.

6. SWITCHING SPECIFICATION

Parameter	Symbol	Min	Typ.	Max.	Unit	Test Condition
Turn-On time	t_{on}	---	1.0	4.0	μs	$R_L=270\Omega, V_{CC}=5V,$ $I_F=I_F(on), T_A =25^\circ C$
Fall Time	t_f	---	0.1	---	μs	
Turn-Off time	t_{off}	---	1.2	4.0	μs	
Rise Time	t_r	---	0.1	---	μs	
Data Rate	---	---	1	---	MHz	

7. Order Information

Part Number

OR-H11LX-U-Y-Z-(GK)

Note

H11LX = Part Number (H11L1, H11L2, H11L3)

U = Lead form option (S, M or none).

Y = Tape and reel option (TA1,TA or none).

Z = 'V' code for VDE safety (This options is not necessary).

GK = Field code.

* VDE Code can be selected.

Option	Description	Packing quantity
None	Standard DIP-6	66 units per tube
TA	Surface mount lead form (low profile) + TA tape & reel option	1000 units per reel
TA1	Surface mount lead form (low profile) + TA1 tape & reel option	1000 units per reel

8. Naming Rule

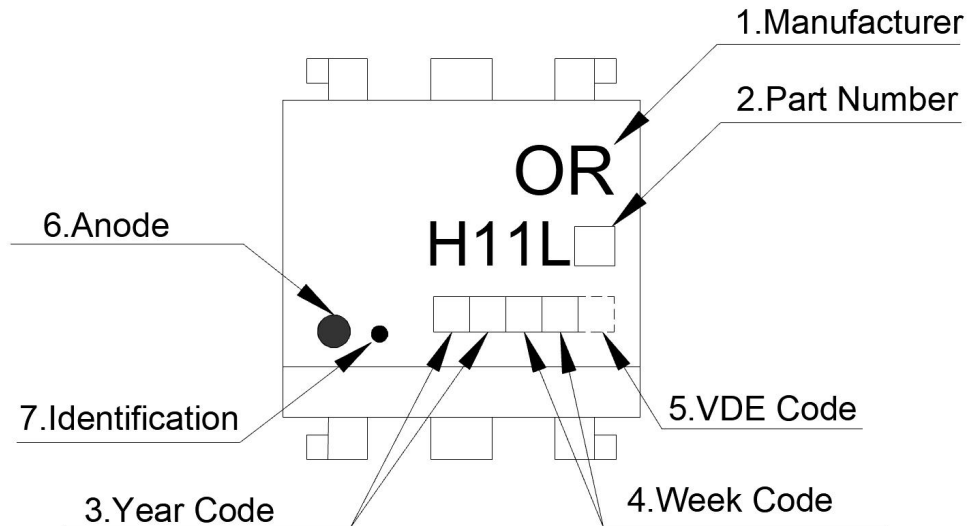

1. Manufacturer : ORIENT.
2. Part Number : H11L□.
3. Year Code □□ : '21' means '2021' and so on.
4. Week Code □□: 01 means the first week, 02 means the second week and so on.
5. VDE Code □□□. (Optional)
6. Anode.
7. Identification.

* VDE Mark can be selected.

9. Outer Dimension

(1) H11LX

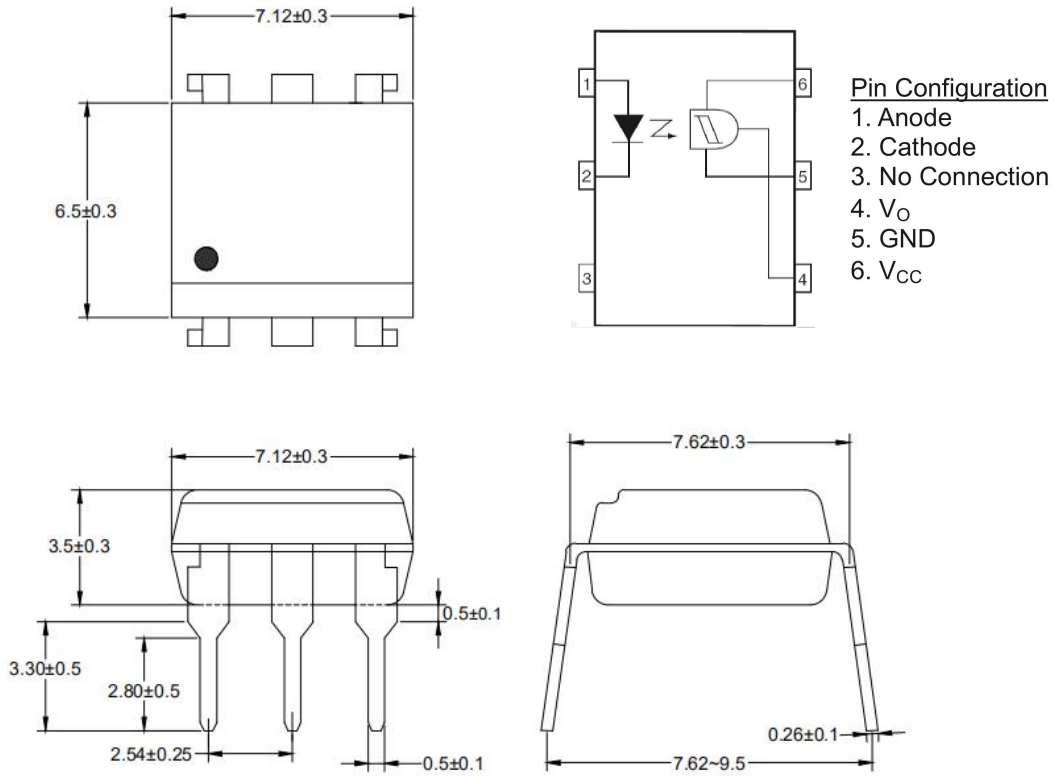

(2) H11LXM

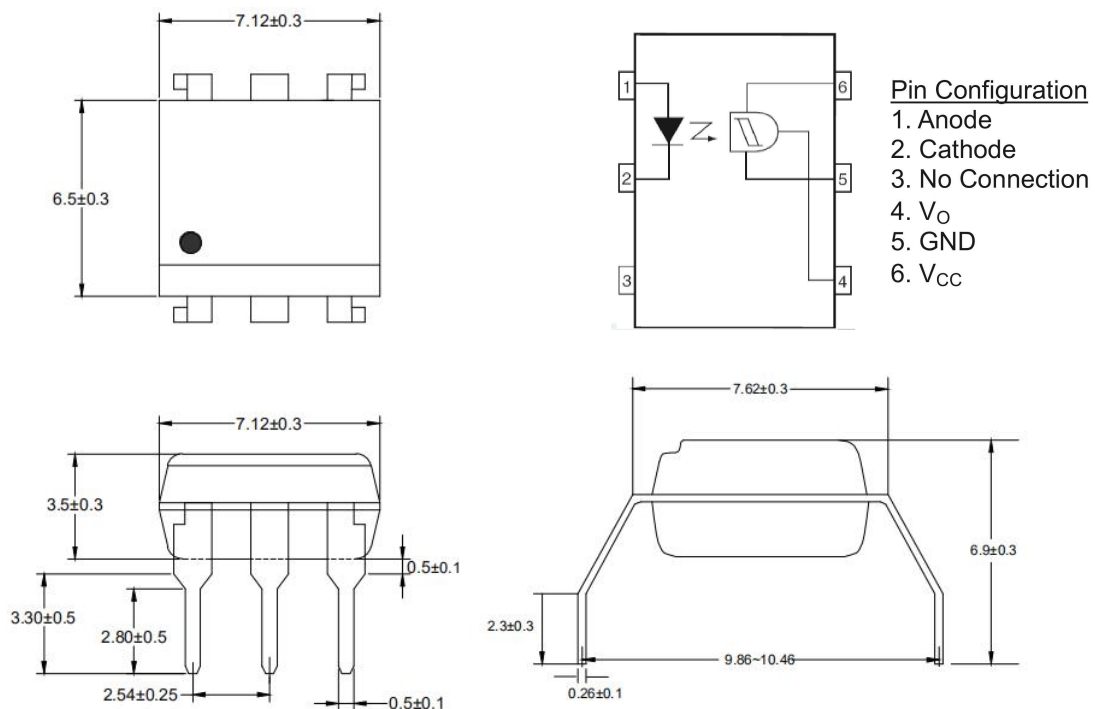

(3) H11LXS

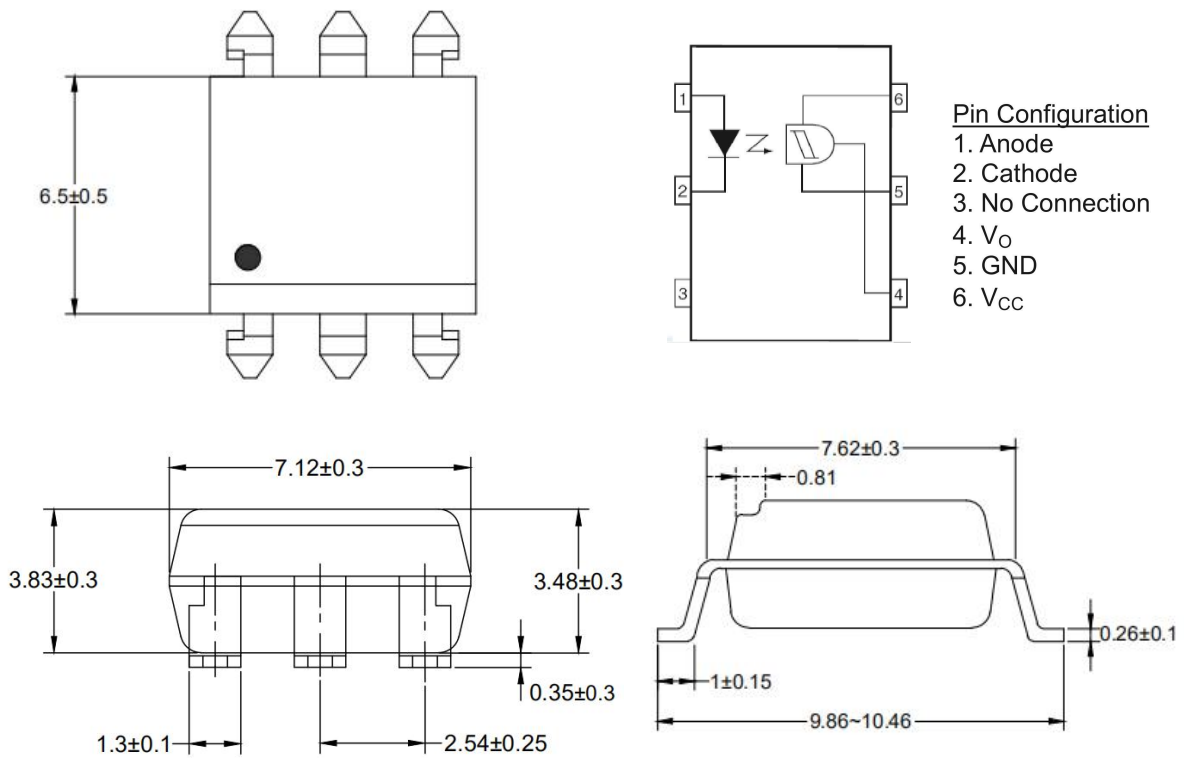

10. Recommended Foot Print Patterns (Mount Pad)

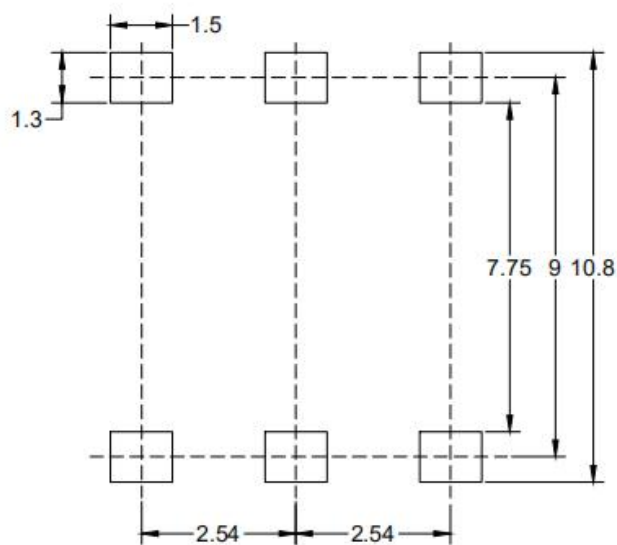

unit: mm

11. Taping Dimensions

(1) OR-H11LXS-TA

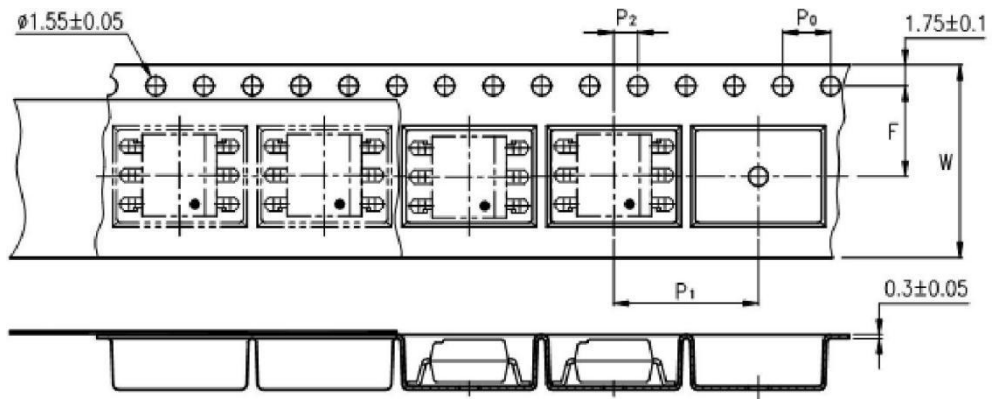

(2) OR-H11LXS-TA1

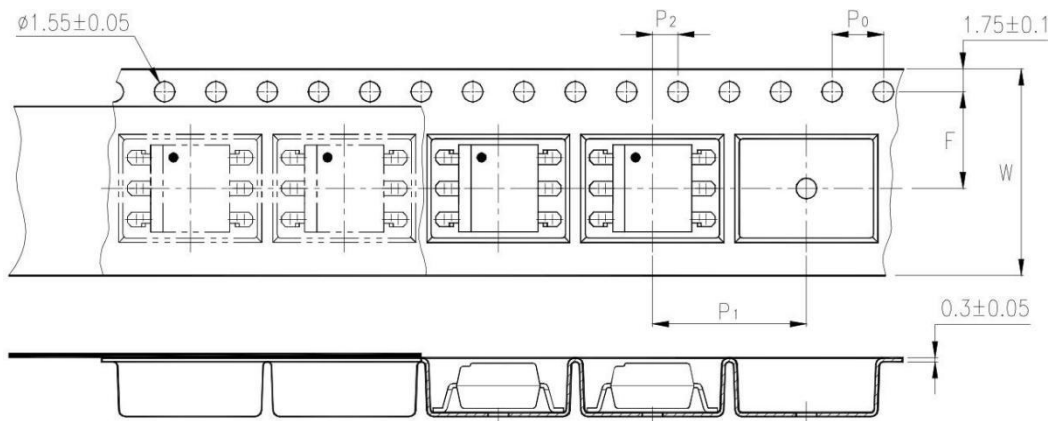

Description	Symbol	Dimension in mm(inch)
Tape wide	W	16±0.3 (0.63)
Pitch of sprocket holes	P0	4±0.1 (0.15)
Distance of compartment	F	7.5±0.1 (0.295)
	P2	2±0.1 (0.079)
Distance of compartment to compartment	P1	12±0.1 (0.472)

Package Type	TA/TA1
Quantities(pcs)	1000

12. Package Dimension

(1) package dimension

DIP Type



Packing Information	
Packing type	Tube
Qty per Tube	66pcs
Small box (Inner) Dimension	525*128*60mm
Large box (Outer) Dimension	545*290*335mm
The Amount per Inner Box	3,300pcs
The Amount per Outer Box	33,000pcs

SOP Type

Packing Information	
Packing type	Reel type
Tape Width	16mm
Qty per Reel	1,000pcs
Small box (inner) Dimension	345*345*58.5mm
Large box (Outer) Dimension	620x360x360mm
Max qty per small box	2,000pcs
Max qty per large box	20,000pcs

(2)Packing Label Sample



Material Code : 120PCXXXXXX

 P/N : OR-XXXXXX

 Lot No. : XXXXXX-XXXX-TX-X

 D/C : XXXX

 Qty : XXXX PCS





内箱码

外箱码

“XXXXXXXXXXXXXXXXXX” (一体机序列码)

Made in China

Note:

1. Material Code :Product ID.
2. P/N :Contents with "Order Information" in the specification.
3. Lot No. :Product data.
4. D/C :Product weeks.
5. Quantity :Packaging quantity.

13. Temperature Profile Of Soldering

(1) IR Reflow soldering (JEDEC-STD-020C compliant)

One time soldering reflow is recommended within the condition of temperature and time profile shown below.
Do not solder more than three times.

Profile item	Conditions
Preheat	
- Temperature Min (T Smin)	150°C
- Temperature Max (T Smax)	200°C
- Time (min to max) (ts)	90±30 sec
Soldering zone	
- Temperature (TL)	217°C
- Time (t L)	60 sec
Peak Temperature	260°C
Peak Temperature time	20 sec
Ramp-up rate	3°C / sec max.
Ramp-down rate from peak temperature	3~6°C / sec
Reflow times	≤3

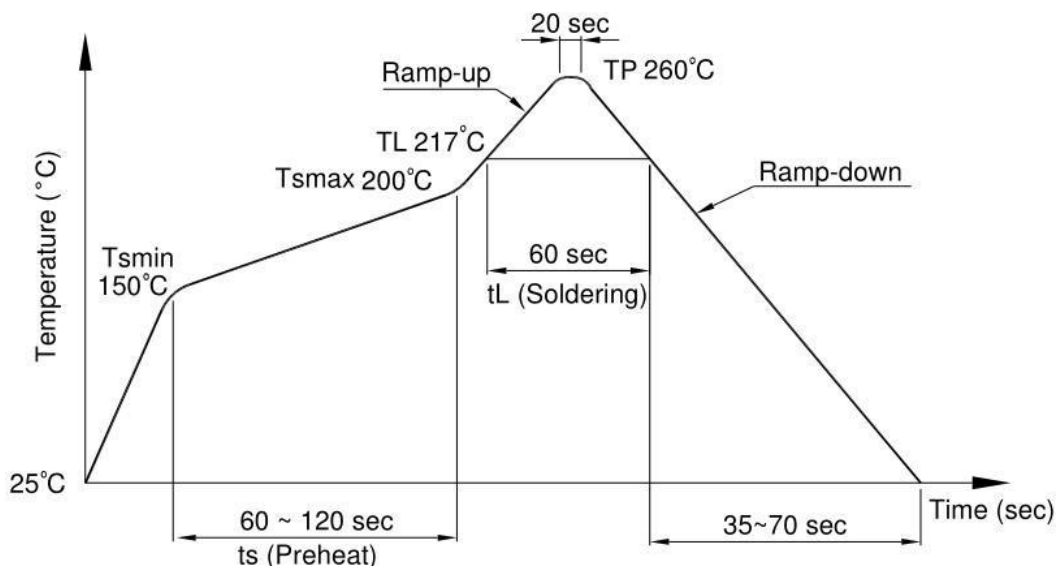

(2) Wave soldering (JEDEC22A111 compliant)

One time soldering is recommended within the condition of temperature.

Temperature	260+0/-5°C
Time	10 sec
Preheat temperature	5 to 140°C
Preheat time	30 to 80 sec

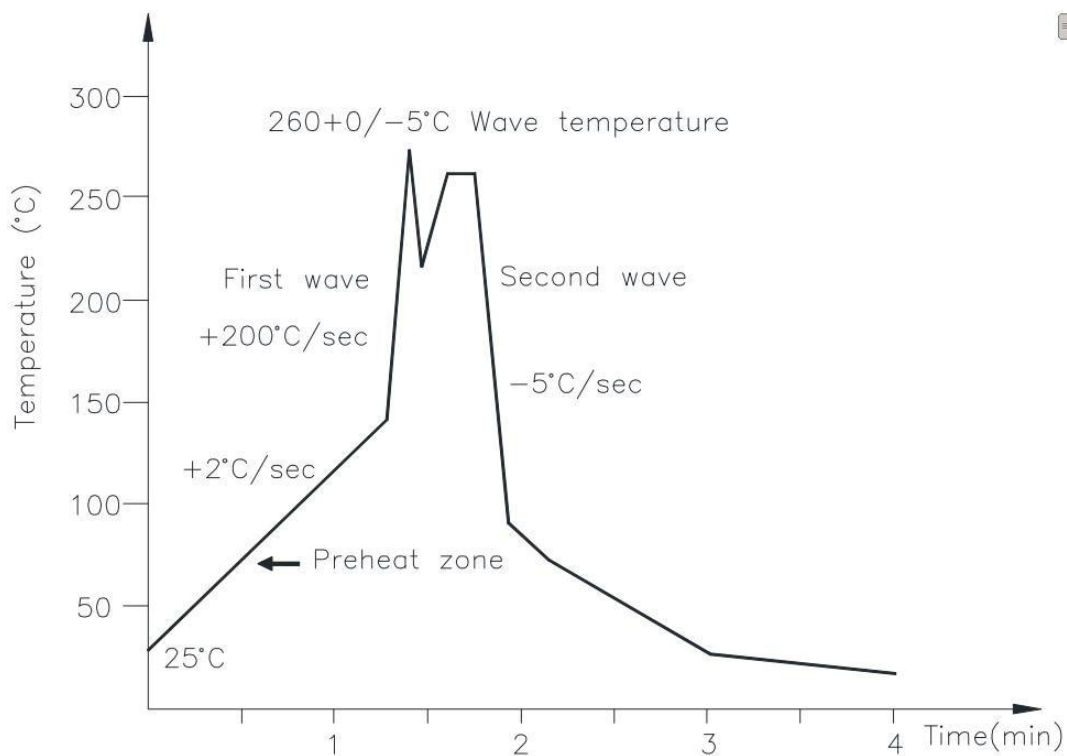

(3) Hand soldering by soldering iron

Allow single lead soldering in every single process. One time soldering is recommended.

Temperature	380+0/-5°C
Time	3 sec max

14. Characteristics Curve

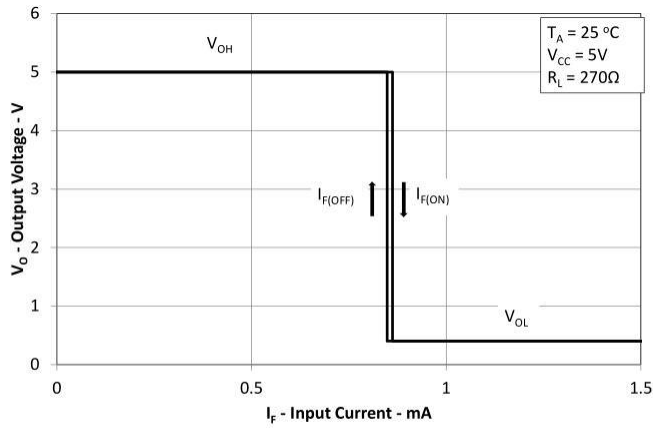

Figure 1. Transfer Characteristic

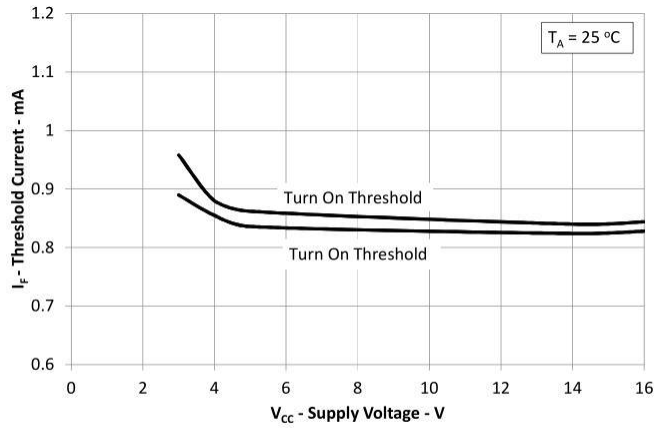

Figure 2. Threshold Current vs. Supply Voltage

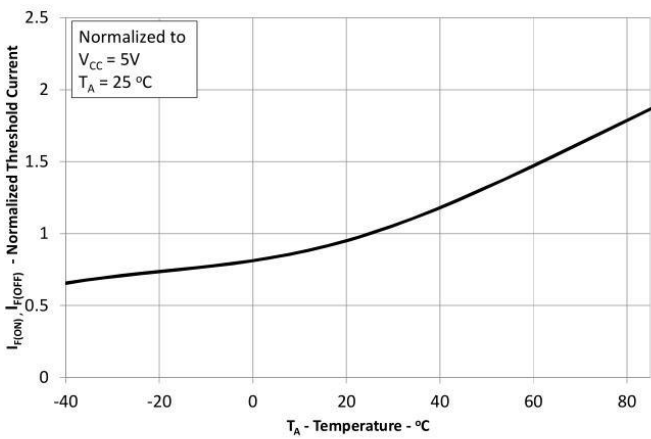

Figure 3. Threshold Current vs. Supply Temperature

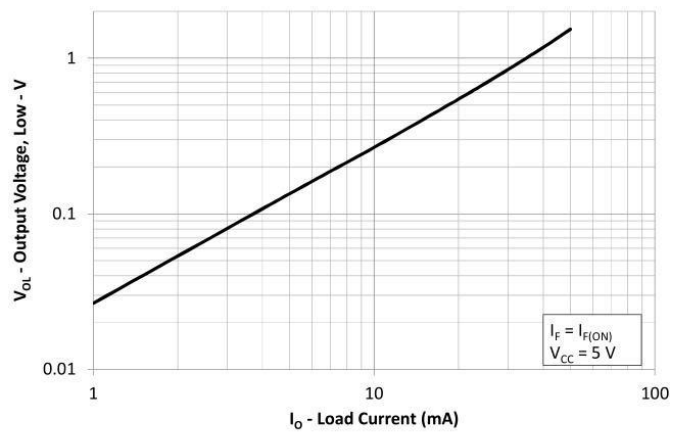

Figure 4. Output Voltage, Low vs. Load Current

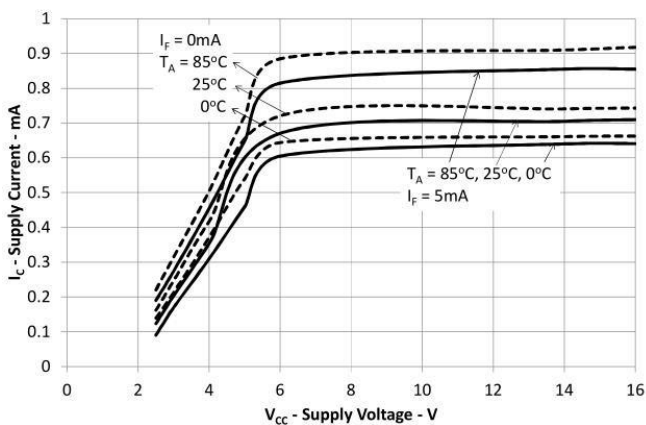

Figure 5. Supply Current vs. Supply Voltage

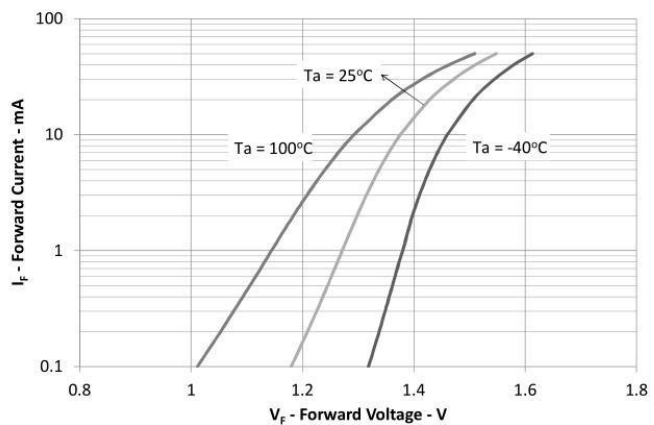

Figure 6. Forward Current vs. LED Forward Voltage

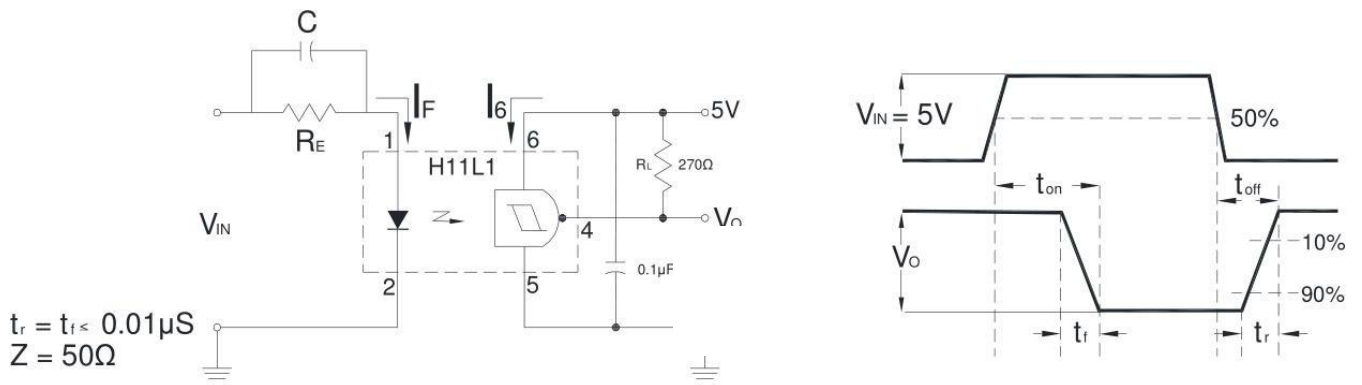

Figure 7. Switching Test Circuit and Waveform