



SPECIFICATION

Customer Name					
Customer No.					
Product Description			Side View PT Lamp LED		
Product Model			ORL-PT908-7C-F		
Orient Confirm			Customer Confirm		
Approved by	Checked by	Prepared by	Approved by	Quality	Engineering
Huangshenghuang	Huanghaijun	Sushiheng			
Judge outcome:		OK	Judge outcome:		



静电敏感元件



Add: Block A 3rd Floor No.4 Building, Tian'an Cyber Park, Huangge Rd, LongGang Dist, Shenzhen, GD

TEL: 0755-29681816

FAX: 0755-29681200

URL: www.orient-opto.com



1、 Features



- Fast response time.
- High sensitivity.
- Waterclear packge.
- Small junction capacitance.
- Pb Free.
- This product itself will remain within RoHS compliant version.
- Compliance with EII REACH.
- Compliance Halogen Free (Br < 900ppm, Cl < 900ppm, Br+Cl < 1500ppm)

2、 Applications

- Optoelectronic switch.
- VCR, Video Camera.
- Floppy disk drive.
- Infrared applied system.

3、 Description

- The ORL-PT908-7C-F is a phototransistor in miniature package which is molded in a plastic with spherical top view lens.
- The device is spectrally matched to infrared emitting diode.

4、 Package Outline Dimensions

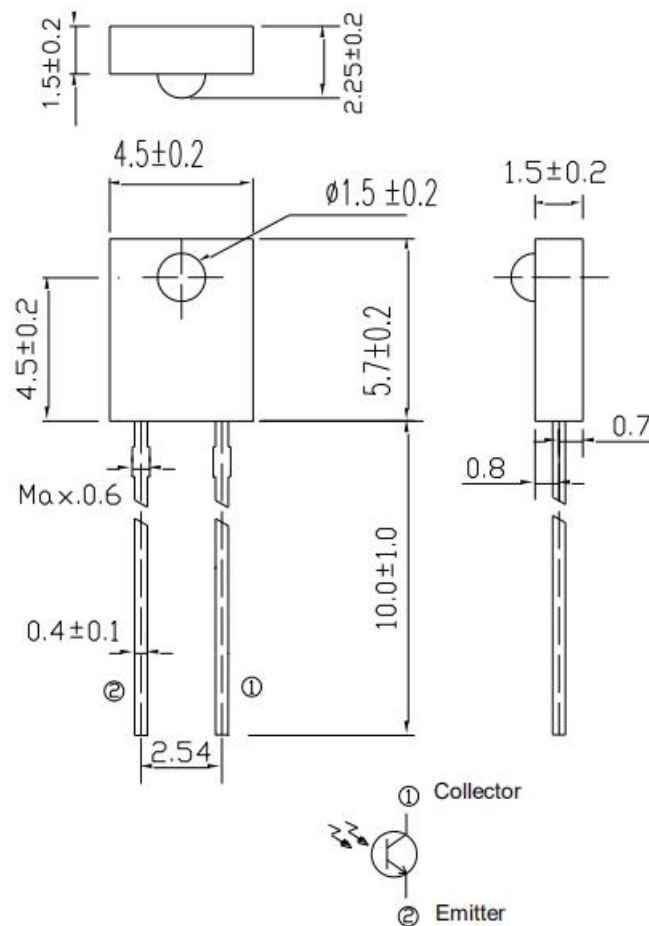

Notes:

- 1).All dimensions are in millimeters.
- 2).Tolerance is ± 0.1 mm unless otherwise specified.
- 3).Specifications are subject to change without notice.



5、 Absolute maximum ratings at Ta=25°C

Parameter	Symbol	Rating	Unit
Power Dissipation	P_D	75	mW
Collector Current	I_C	20	mA
Collector-Emitter Voltage	V_{CEO}	30	V
Emitter-Collector Voltage	V_{ECO}	5	V
Operating Temperature Range	T_{opr}	-25~+85	°C
Storage Temperature Range	T_{stg}	-40~+100	°C
Soldering Temperature	T_{sld}	260	°C

Notes: Soldering time \leq 5 seconds.

6、 Electrical-optical characteristics at Ta=25°C

Parameter	Symbol	Condition	Min.	Typ.	Max.	Unit
Rang of Spectral Bandwidth	$\lambda_{0.5}$	-	450	-	1100	nm
Wavelength of Peak Sensitivity	λ_P	-	-	940	-	nm
Collector-Emitter Breakdown Voltage	BV_{CEO}	$I_C=100\mu A$ $E_e=0mW/cm^2$	30	-	-	V
Emitter-Collector Breakdown Voltage	BV_{ECO}	$I_E=100\mu A$ $E_e=0mW/cm^2$	5	-	-	V
Collector Dark Current	I_{CEO}	$V_{CE}=20V$ $E_e=0mW/cm^2$	-	-	100	nA
Collector-Emitter Saturation Voltage	$V_{CE(sat)}$	$I_C=2mA$ $E_e=1mW/cm^2$	-	-	0.4	V
On State Collector Current	$I_{C(ON)}$	$V_{CE}=5V$ $E_e=0.555mW/cm^2$	0.8	-	5.0	mA

Notes: Tolerance of collector current is $\pm 15\%$.

7、 Rank

Condition: $V_{CE}=5V, E_e=0.555mW/cm^2$

Symbol	Condition	Ranks	Min.	Max.	Unit
$I_{C(ON)}$	$V_{CE}=5V$ $E_e=0.555mW/cm^2$	BIN1	0.80	1.53	mA
		BIN2	1.11	1.98	
		BIN3	1.43	2.68	
		BIN4	1.59	3.06	
		BIN5	2.0	5.0	

Notes: This bin table is only for reference, not for specific bin shipment.

8、 Test Method For $I_{C(ON)}$

Condition: $V_{CE}=5V, E_e=0.555mW/cm^2$

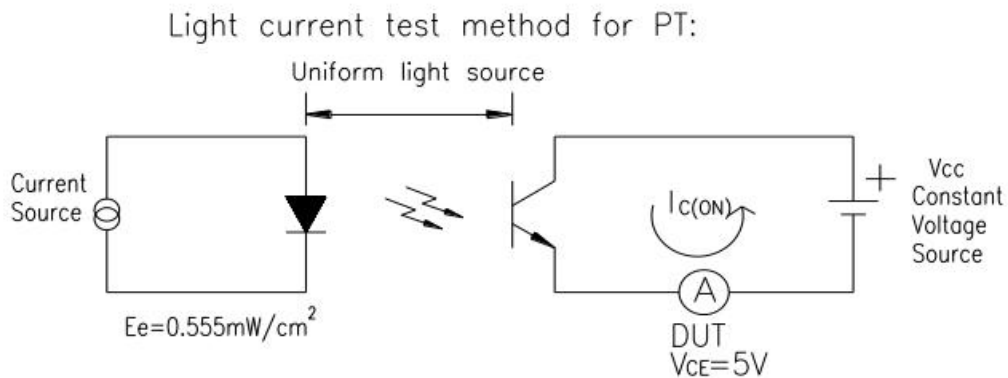

9、Typical optical characteristics curves

Fig.1 Spectral Sensitivity

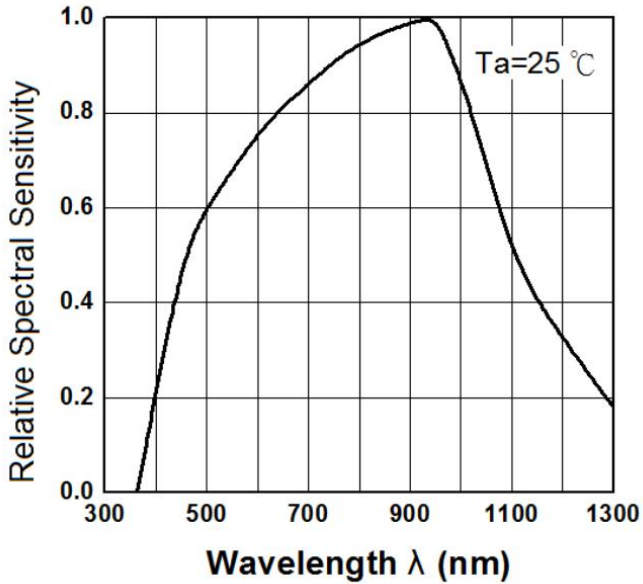

Fig.2 Collector Current vs. Irradiance

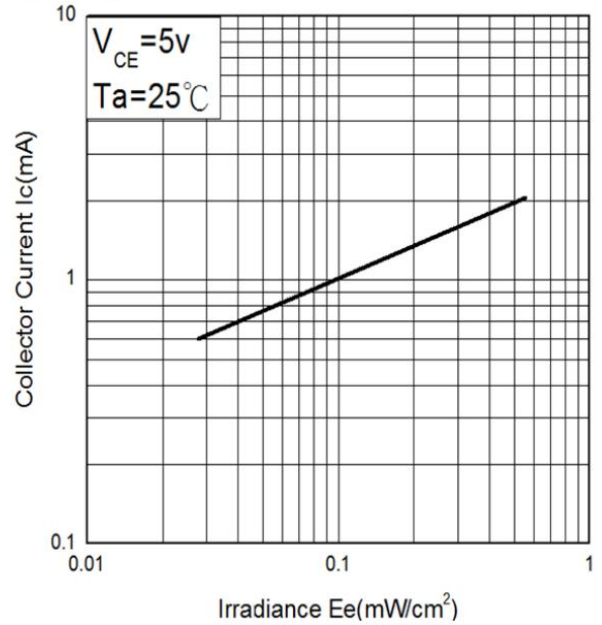
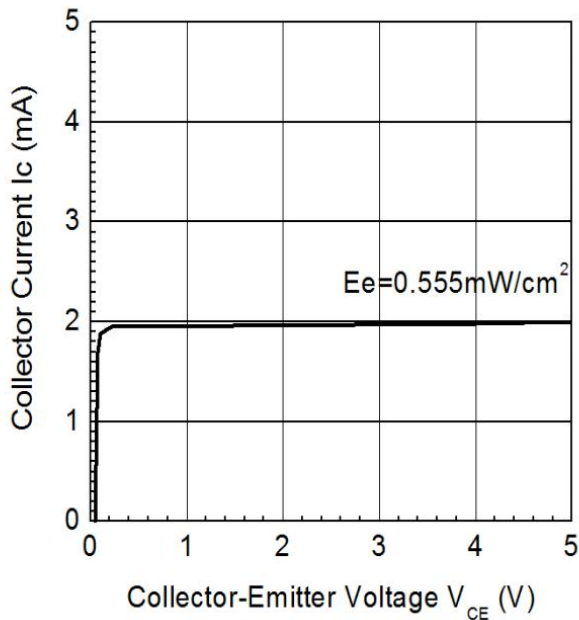

Fig.3 Collector Current vs. Collector-Emitter Voltage





10、 Package and Label of Products

- (1) 1000PCS/1Bag, 8Bags/1Box
- (2) 10Boxes/1Carton
- (3) Label:

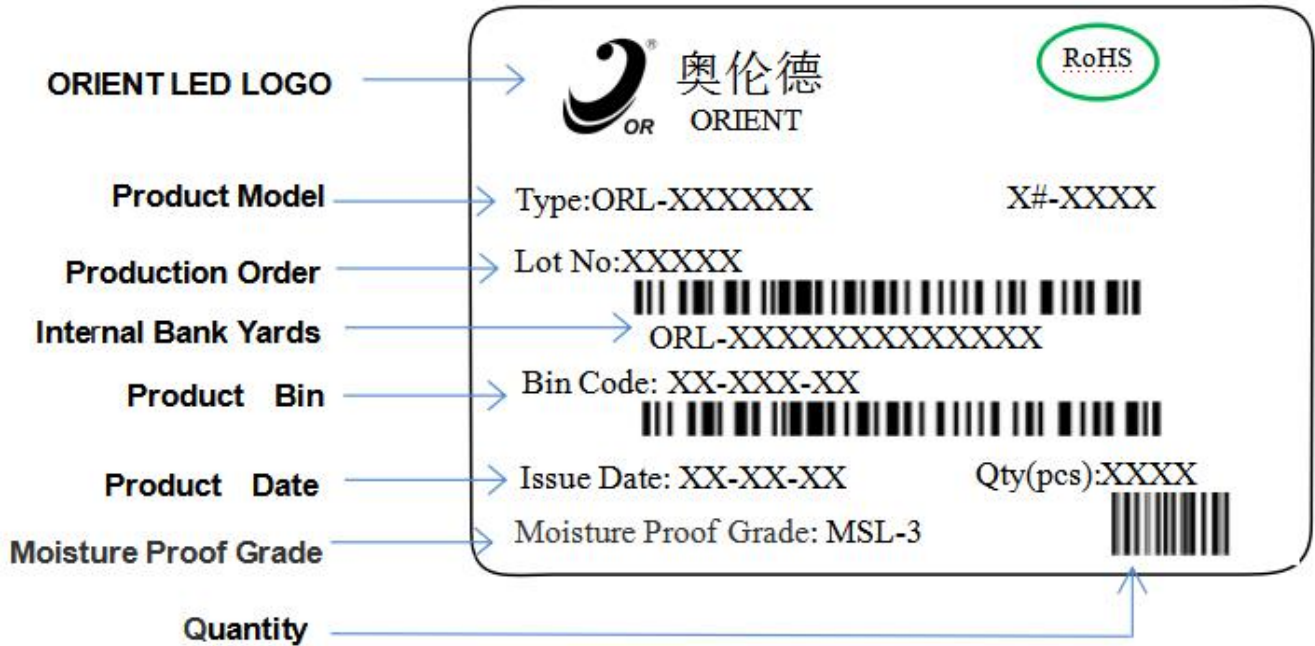

11、Precautions for use

1、Soldering

Careful attention should be paid during soldering. When soldering, leave more than 3mm from solder joint to epoxy bulb, and soldering beyond the base of the tie bar is recommended.

Recommended soldering conditions:

Hand Soldering		DIP Soldering	
Temp. at tip of iron	300°C Max. (30W Max.)	Preheat temp.	100°C Max. (60 sec Max.)
Soldering time	3 sec Max.	Bath temp. & time	260 Max., 5 sec Max
Distance	3mm Min. (From solder joint to epoxy bulb)	Distance	3mm Min. (From solder joint to epoxy bulb)

wave profile:

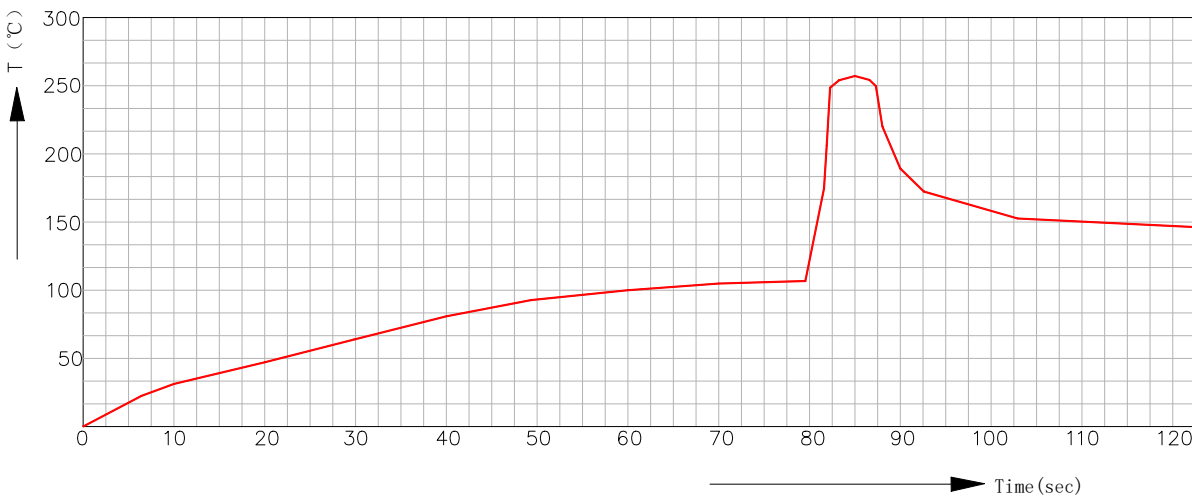

2、Cleaning

2.1. Don't be cleaned with ultrasonic. Recommended to be wiped with isopropyl alcohol or pure alcohol, wiping time should not be more than one minute. LED must be placed at room temperature for fifteen minutes before using. After cleaning, you must insure clean on the radiant surface. Otherwise, foreign objects can affect radiant color.

2.2. LED can not be in contact with isoamyl acetate, trichloroethylene, acetone, sulfide, nitride, acid, alkali, salt. These matter can destroy LED.

3、Sealing

3.1. Sealing glue can not contain sodium ion, sulfide, because these matter can affect fluorescence powder poisoning.

3.2. When using normal sealing glue, Recommended to be operated life for 168hrs under normal temperature.



4、 Storage

- 4.1. Don't open the moisture proof bag before ready to use the LEDs.
- 4.2. The LEDs should be kept at 30°C or less and 60%RH or less before opening the package. The max. storage period before opening the package is 1 year.
- 4.3. After opening the package, the LEDs should be kept at 30-35%RH or less, and it should be used within 3 days. If the LEDs should be kept at 30-35%RH or more, and it should be used within 4 hours.
- 4.4. If the LEDs be kept over the conditions of 20%, baking is required before mounting. Baking condition as below: 70±5°C for 12 hrs for bulk goods, 105±5°C for 1 hrs for roll goods.
- 4.5. The environment have no acid, alkali, corrosive gas, intensively shake and high magnetic field.

5、 Static

- 5.1. Static and Peak surge voltage can destroy LED, Avoiding Instantaneous voltage when turn on or turn off the lights.
- 5.2. Please wear Anti-static wrist band, Anti-static glove, Anti-static shoes in the course of operation, and the equipment must be grounded.

6、 Test

- 6.1. Customer must apply the current limiting resistor in the circuit so as to drive the LEDs within the rated current. Otherwise slight voltage shift maybe will cause big current change and burn out will happen.
- 6.2. Also, caution should be taken not to overload the LEDs with instantaneous high voltage at the turning ON and OFF of the circuit. Otherwise, The LEDs will be destroyed, testing methods as follows:
- 6.3. The reverse voltage mustn't exceed 5v when lighting on or testing the LED, otherwise, The LEDs will be damaged.

7、 Else

Radiant color of LEDs have a little change with the current, recommended that LED is used in series and resistance, when lighting, please don't see directly radiant surface of LED, otherwise LED will burn eyes.