



SPECIFICATION

Customer Name					
Customer No.					
Product Description			0603 Top View White LED		
Product Model			OR-W0603Z4-YC-4T		
Orient Confirm			Customer Confirm		
Approved by	Checked by	Prepared by	Approved by	Quality	Engineering
Linshixiu	Huanghaijun	Sushiheng			
Judge outcome:		OK	Judge outcome:		



静电敏感元件



Add: Building 1,21 Jinhui Road, Jianghai district, Jiangmen

TEL: +86-750-3697838

URL: www.orient-opto.com



1、 Features

- Emitted Color : White.
- 1.6x0.8x0.4mm(0603) standard package.
- Suitable for all SMT assembly methods.
- Compatible with infrared and vapor phase reflow solder process.
- Compatible with automatic placement equipment.
- This product doesn't contain restriction substance, comply RoHS standard.



2、 Applications

- Indicator and backlighting.
- Flat backlight for LCD, switch and symbol.
- General use.

3、 Package Outline Dimensions

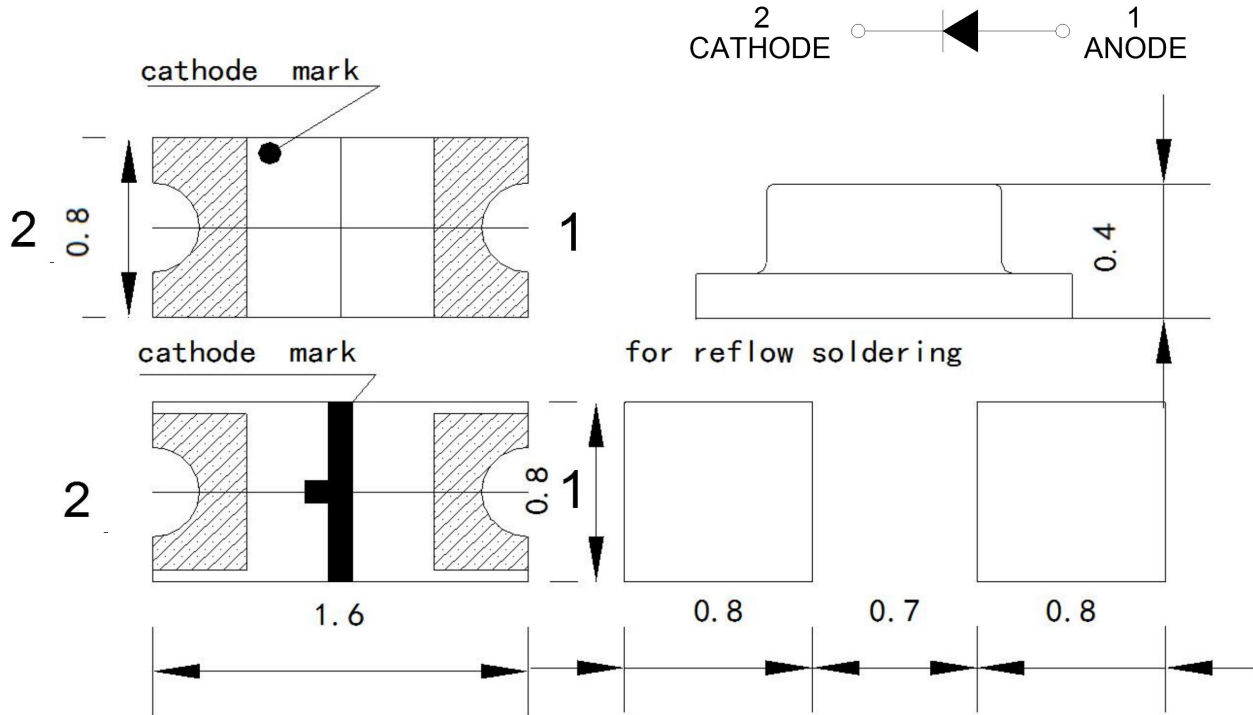

Notes:

- 1). All dimensions are in millimeters (inches).
- 2). Tolerance is $\pm 0.10\text{mm}$ (0.004") unless otherwise specified.
- 3). Specifications are subject to change without notice.



4、 Absolute maximum ratings at Ta=25°C

Parameter	Symbol	Rating	Unit
Power Dissipation	P _D	85	mW
Forward Current	I _F	25	mA
Peak Forward Current *1	I _{FP}	100	mA
Reverse Voltage	V _R	5	V
Operating Temperature Range	T _{opr}	-40~+85	°C
Storage Temperature Range	T _{stg}	-40~+100	°C
Electrostatic Discharge	ESD	2000(HBM)	V
Soldering Temperature	T _{sld}	Reflow Soldering:260°C ≤10 secs	

Notes: *1 Condition for I_{FP} is pulse of 1/10 duty and 0.1msec width.

5、 Electrical-optical characteristics at Ta=25°C

Parameter	Condition	Symbol	Min.	Typ.	Max.	Unit
Forward Voltage	I _F =2mA	V _F	2.6	2.9	3.0	V
Luminous Intensity	I _F =2mA	I _v	60	85	115	mcd
Reverse Current	V _R =5V	I _R	-	-	1	uA
Chromaticity Coordinates	I _F =2mA	x	-	0.30	-	-
	I _F =2mA	y	-	0.28	-	-
Viewing Angle	I _F =2mA	2θ _{1/2}	-	130	-	deg

Notes:

- 1、 Tolerance of luminous flux is ±10%.
- 2、 Tolerance of forward voltage is ±0.1V.

6、Typical optical characteristics curves

Fig.1 Relative intensity vs. wavelength

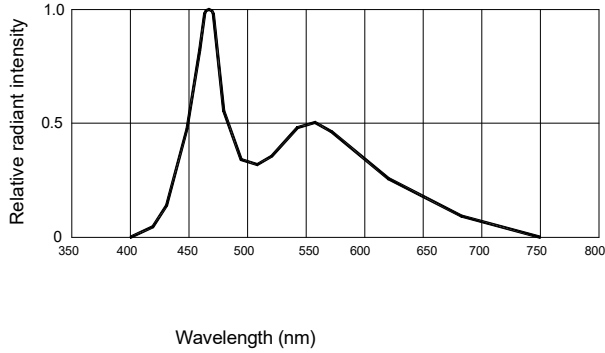

Fig.2 Forward current derating curve vs. ambient temperature

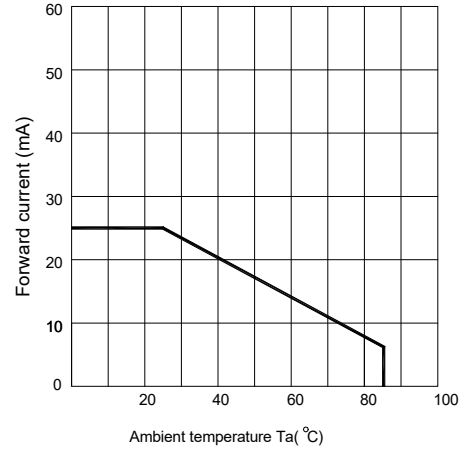

Fig.3 Forward current vs. forward voltage

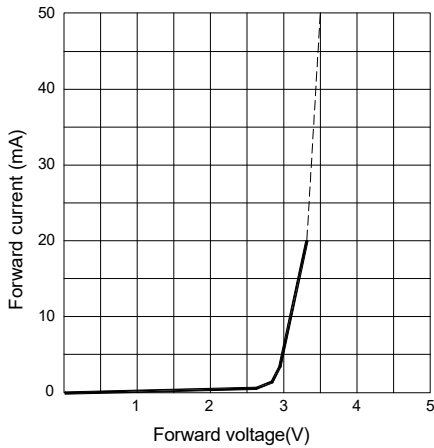

Fig.4 Relative luminous intensity vs. ambient temperature

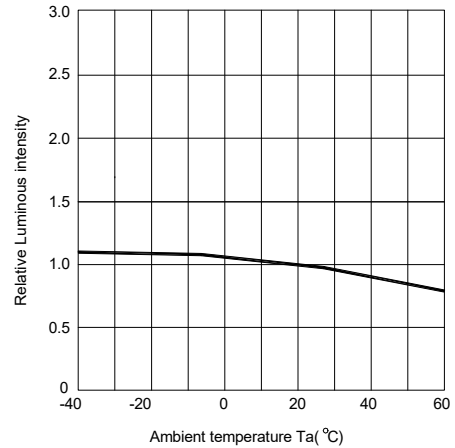

Fig.5 Relative luminous intensity vs. forward current

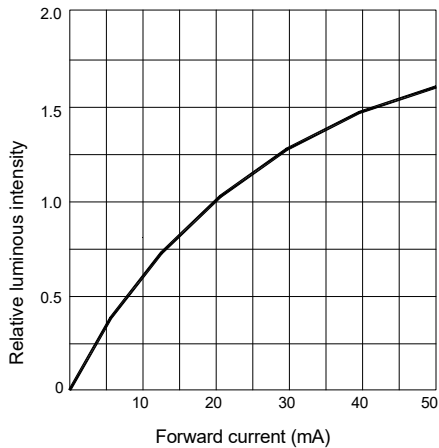
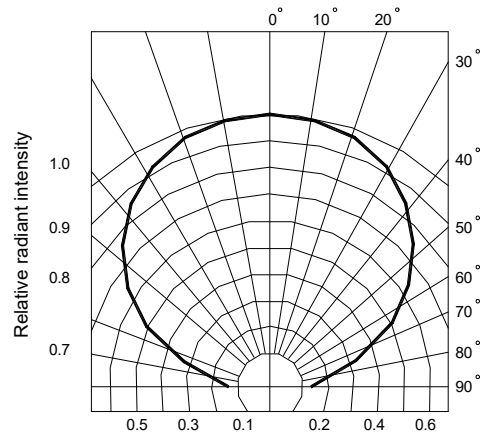

Fig.6 Radiation diagram





7、 Bin Limits

Intensity Bin Limits (At 2mA)

BIN CODE	Min.(mcd)	Max.(mcd)
Q	60	75
R	75	90
S	90	115

Notes: Tolerance for each Bin limit is $\pm 10\%$.

V_F Bin Limits (At 2mA)

BIN CODE	Min.(V)	Max.(V)
F1	2.6	2.7
F2	2.7	2.8
G1	2.8	2.9
G2	2.9	3.0

Notes: Tolerance for each Bin limit is $\pm 0.1V$.

Color Ranks(At 2mA)

BIN Code	x	y	BIN Code	x	y	BIN Code	x	y
44	0.235	0.24	45	0.245	0.25	46	0.255	0.26
	0.245	0.25		0.255	0.26		0.265	0.27
	0.265	0.25		0.275	0.26		0.285	0.27
	0.255	0.24		0.265	0.25		0.275	0.26
47	0.265	0.27	48	0.275	0.28	49	0.285	0.29
	0.275	0.28		0.285	0.29		0.295	0.3
	0.295	0.28		0.305	0.29		0.315	0.3
	0.285	0.27		0.295	0.28		0.305	0.29

Notes: Measurement uncertainty of the color coordinates: ± 0.008 .



8、 CIE Chromaticity Diagrams

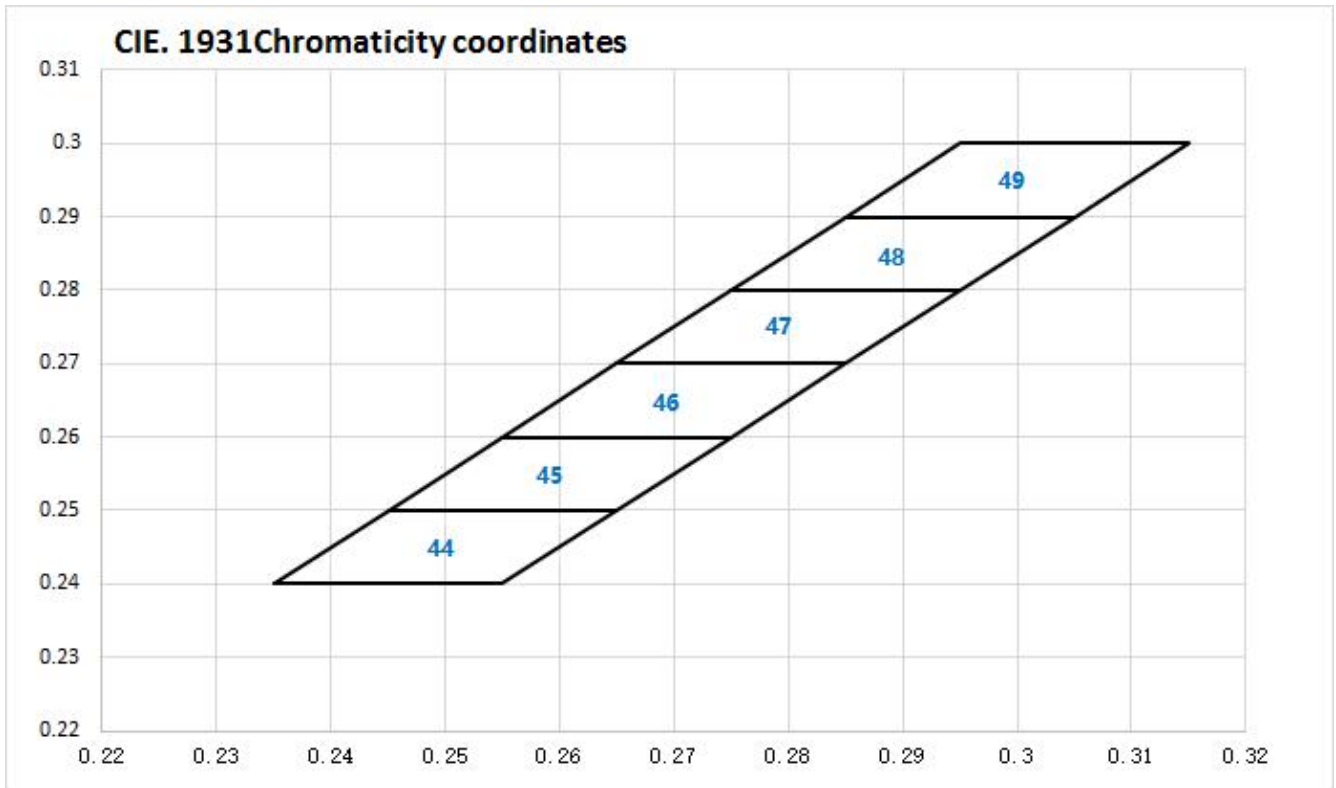

9、Packaging Specification

●Dimensions for Reel (Unit: mm)

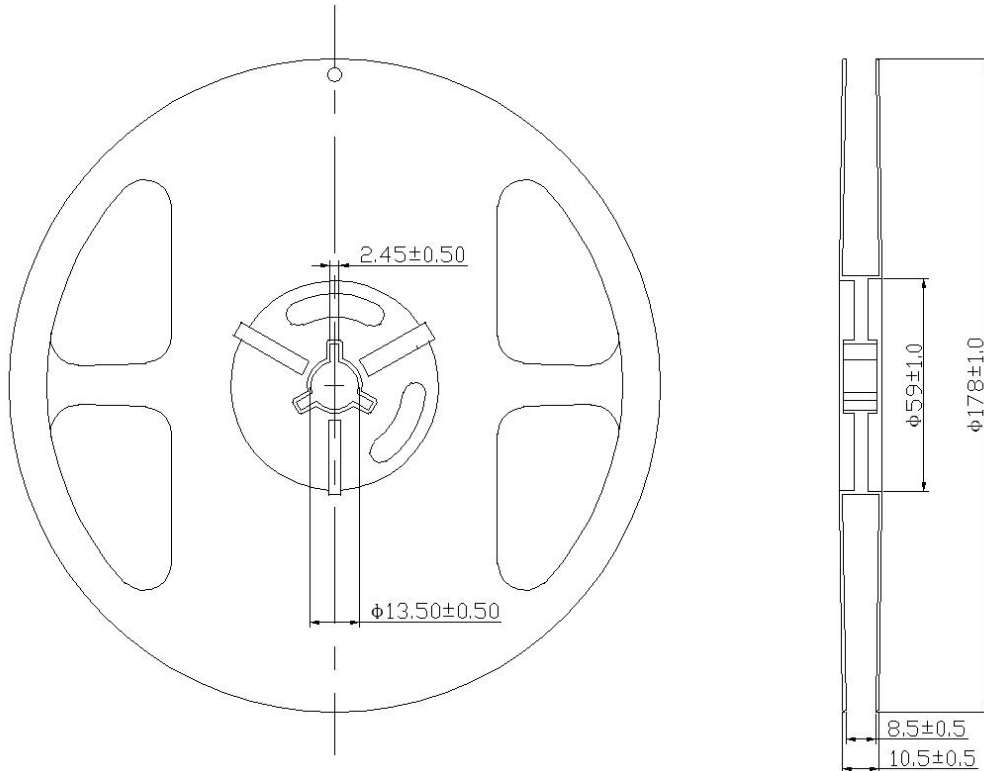

●Dimensions of Tape (Unit: mm)

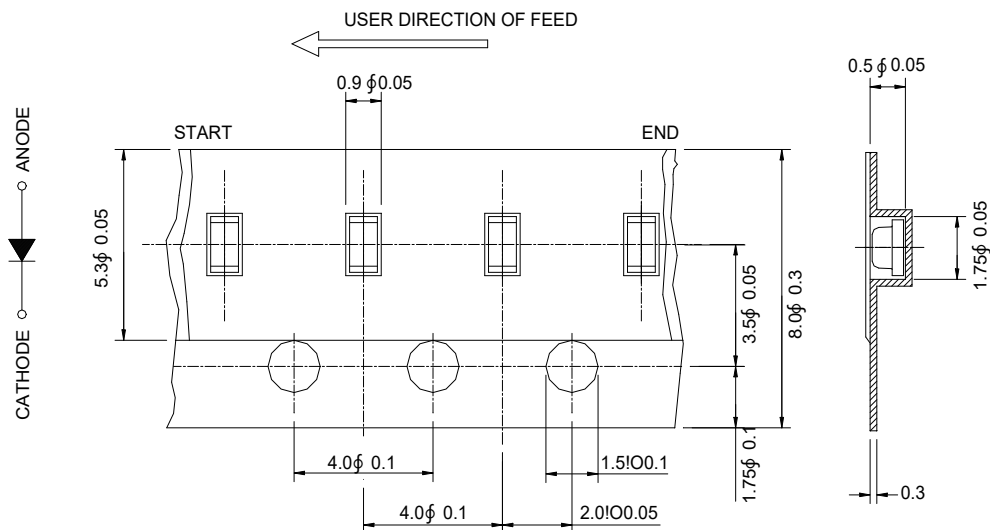

Notes:

- 1、 All dimensions are in mm, tolerance is ± 0.1 mm unless otherwise noted.
- 2、 Specifications are subject to change without notice.
- 3、 Loaded quantity: 4000 pcs/reel.



●Package Method: Vacuum (Unit: mm)

50bag/box

4000pcs/bag

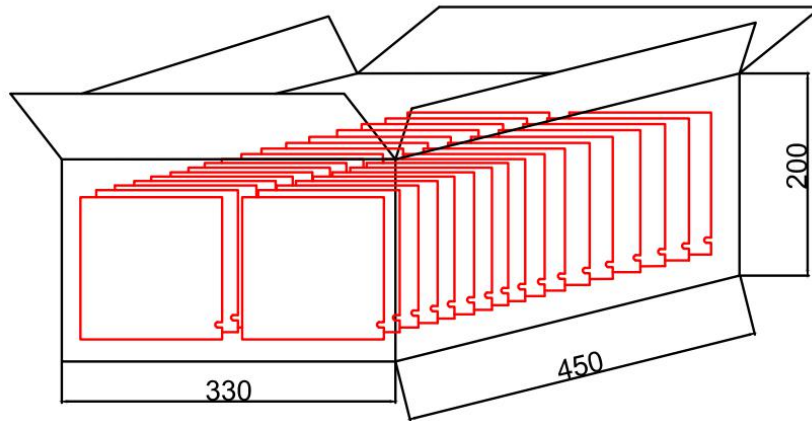

10、Label description

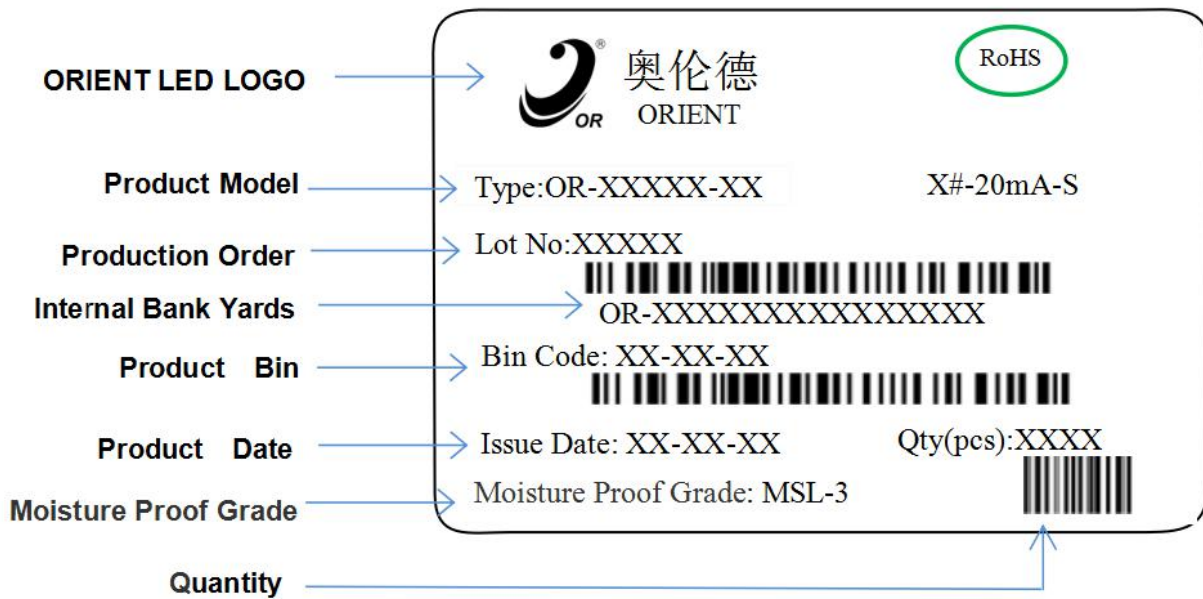

●BIN description: X - X - X

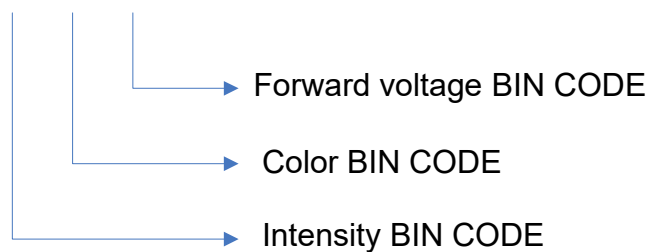

11、Precautions for use

1、Soldering

SMD LED encapsulation is very flexible, outside force easily demolish radiant surface and plastic, As soldering , Please handle with care !

1.1. With No-clean Flux, according to reflow soldering cure condition when soldering, Reflow soldering should not be done more than two times, simultaneity you must insure clean on the radiant surface. Otherwise, foreign objects can affect radiant color.

1.2. Don't process manual soldering except repair. Recommended to be soldered with 25W Anti-static iron, The temp. of the iron should be lower than 300°C and soldering time should not be done more than three seconds, at the same time iron can't touch radiant surface and plastic.

1.3. Don't twist LED in course of manual soldering and experiment, otherwise, the lights will not work possibly.

1.4. Please use the same BIN grade in one panel, and don't mix the difference BIN grade in one panel when soldering. Otherwise, it will cause a serious uneven color problem.

1.5. Please control the sulfur content of solder paste and PCB.

1.6. Pb-free solder temp.-time profile as below:260°C Max

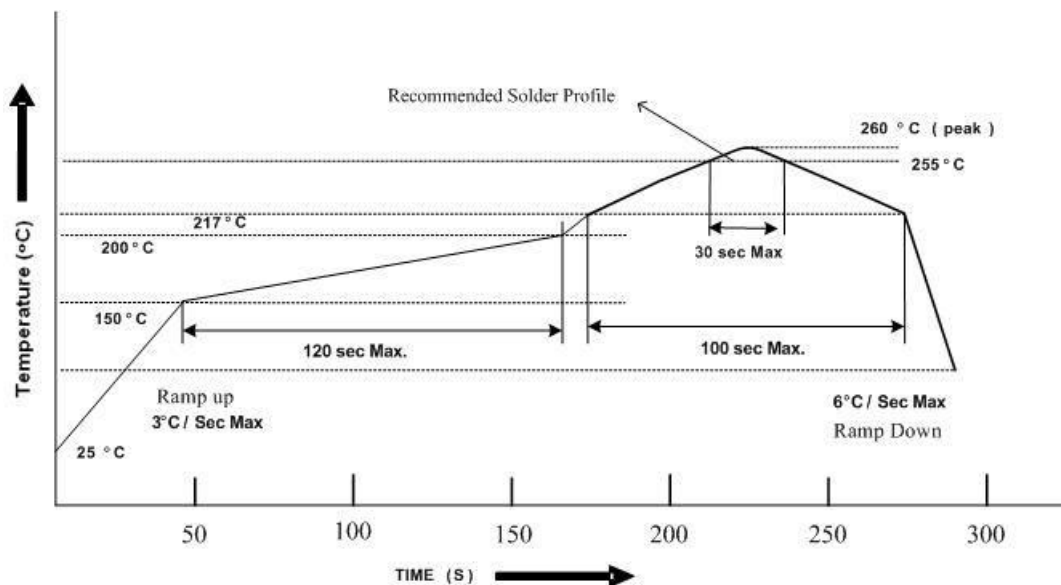

2、Cleaning

2.1. Don't be cleaned with ultrasonic. Recommended to be wiped with isopropyl alcohol or pure alcohol, wiping time should not be more than one minute. LED must be placed at room temperature for fifteen minutes before using. After cleaning, you must insure clean on the radiant surface. Otherwise, foreign objects can affect radiant color.

2.2. LED can not be in contact with isoamyl acetate, trichloroethylene, acetone, sulfide, nitride, acid, alkali, salt. These matter can destroy LED.

3、Sealing

3.1. Sealing glue can not contain sodium ion, sulfide, because these matter can affect fluorescence powder poisoning.

3.2. When using normal sealing glue, Use within 168 hours after opening



4、 Storage

- 4.1. Don't open the moisture proof bag before ready to use the LEDs.
- 4.2. The LEDs should be kept at 30°C or less and 60%RH or less before opening the package. The max. storage period before opening the package is 1 year.
- 4.3. After opening the package, the LEDs should be kept at 30-35%RH or less, and it should be used within 3 days. If the LEDs should be kept at 30-35%RH or more, and it should be used within 4 hours.
- 4.4. If the LEDs be kept over the conditions of 20%, baking is required before mounting. Baking condition as below: 70±5°C for 12 hrs for bulk goods, 105±5°C for 1 hrs for roll goods.
- 4.5. The environment have no acid, alkali, corrosive gas, intensively shake and high magnetic field.

5、 Static

- 5.1. Static and Peak surge voltage can destroy LED, Avoiding Instantaneous voltage when turn on or turn off the lights.
- 5.2. Please wear Anti-static wrist band, Anti-static glove, Anti-static shoes in the course of operation, and the equipment must be grounded.

6、 Test

- 6.1. Customer must apply the current limiting resistor in the circuit so as to drive the LEDs within the rated current. Otherwise slight voltage shift maybe will cause big current change and burn out will happen.
- 6.2. Also, caution should be taken not to overload the LEDs with instantaneous high voltage at the turning ON and OFF of the circuit. Otherwise, The LEDs will be destroyed, testing methods as follows:
- 6.3. The reverse voltage mustn't exceed 5v when lighting on or testing the LED, otherwise, The LEDs will be damaged.

7、 Else

Radiant color of LEDs have a little change with the current, recommended that LED is used in series and resistance, when lighting, please don't see directly radiant surface of LED, otherwise LED will burn eyes.