



# ORIENT

## Photo coupler

# Product Data Sheet

Part Number: OR-357-(CG)

Customer: \_\_\_\_\_

Date: \_\_\_\_\_

**SHENZHEN ORIENT COMPONENTS CO.,LTD.**

Block A 3rd Floor No.4 Building, Tian'an Cyber Park, Huangge Rd, LongGang Dist, Shenzhen, GD

TEL: 0755-29681816

FAX: 0755-29681200

[www.orient-opto.com](http://www.orient-opto.com)

## 1. Features

- (1) Current transfer ratio(CTR : MIN. 50% at  $I_F = 5\text{mA}$ ,  $V_{CE} = 5\text{V}$ ,  $T_a = 25^\circ\text{C}$ )
- (2) High input -output isolation voltage (  $V_{ISO} = 3,750\text{V}_{rms}$  )
- (3) High collector-emitter voltage (  $V_{CEO} = 80\text{V}$  )
- (4) SOP-4 package
- (5) Operating Temperature  $-55^\circ\text{C}$  to  $125^\circ\text{C}$
- (6) ESD pass HBM 8000V/MM 2000V
- (7) Safety approval
  - UL approved(No.E323844)
  - VDE approved(No.40029733)
  - CQC approved (No.CQC19001231256)
- (8) AEC-Q101 qualified
- (9) In compliance with RoHS, REACH standards
- (10) MSL Class I



## 2. Instructions

- The OR-357-(CG) series device consists of an infrared led, photo transistor detector. They are encapsulated in a 4 pin SOP encapsulation.
- Pin pitch of OR-357-(CG) is 2.54mm

## 3. Application Range

- (1) Hybrid substrates that require high density mounting.
- (2) Programmable controllers
- (3) System appliance, measuring instruments

## 4. Functional Diagram

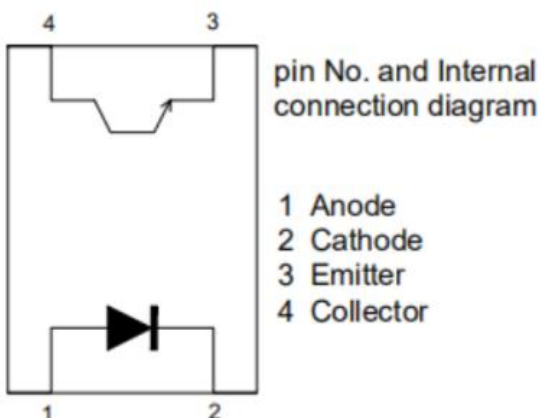

## 5. Max Absolute rated Value (Normal Temperature=25°C)

	Parameter	Symbol	Rated Value	Unit
Input	Forward Current	$I_F$	50	mA
	Junction Temperature	$T_J$	125	°C
	Reverse Voltage	$V_R$	6	V
	Consume Power	$P$	70	mW
Output	Collector and emitter Voltage	$V_{CEO}$	80	V
	Emitter and collector Voltage	$V_{ECO}$	7	
	Collector Current	$I_C$	50	mA
	Consume Power	$P_C$	150	mW
Total Consume Power		$P_{tot}$	200	mW
*1 Insulation Voltage		$V_{iso}$	3750	Vrms
Working Temperature		$T_{opr}$	-55 to + 125	°C
Deposit Temperature		$T_{stg}$	-55 to + 150	
*2 Soldering Temperature		$T_{sol}$	260	

\*1. AC Test, 1 minute, humidity = 40~60%

Insulation test method as below:

- (1) Short circuit both terminals of photo coupler.
- (2) No Current when testing insulation voltage.
- (3) Adding sine wave voltage when testing.

\*2. soldering time is 10 seconds.

## 6. Opto-electronic Characteristics

	Parameter	Symbol	Min	Typ.*	Max	Unit	Condition
Input	Forward Voltage	$V_F$	---	1.2	1.4	V	$I_F=20\text{mA}$
	Reverse Current	$I_R$	---	---	5	$\mu\text{A}$	$V_R=5\text{V}$
	Collector capacitance	$C_t$	---	30	250	pF	$V=0, f=1\text{KHz}$
Output	Collector to emitter Current	$I_{CEO}$	---	---	100	nA	$V_{CE}=20\text{V}, I_F=0\text{mA}$
	Collector and Emitter attenuation Voltage	$BV_{CEO}$	80	---	---	V	$I_C=0.1\text{mA}, I_F=0\text{mA}$
	Emitter and Collector attenuation Voltage	$BV_{ECO}$	7	---	---	V	$I_E=0.1\text{mA}, I_F=0\text{mA}$
Transforming Characteristics	*1.Current conversion ratio	CTR	50	---	600	%	$I_F=5\text{mA}, V_{CE}=5\text{V}$
	Collector Current	$I_C$	2.5	---	30	mA	
	Collector and Emitter Saturation Voltage	$V_{CE(sat)}$	---	---	0.2	V	$I_F=20\text{mA}, I_C=1\text{mA}$
	Insulation Impedance	$R_{iso}$	$5 \times 10^{10}$	$1 \times 10^{11}$	---	$\Omega$	DC500V 40~60%R.H.
	Floating Capacitance	$C_f$	---	0.6	1	pF	$V=0, f=1\text{MHz}$
	Response Time	$t_r$	---	4	18	$\mu\text{s}$	$V_{CC}=2\text{V}, I_C=2\text{mA}, R_L=100\Omega$
	Descend Time	$t_f$	---	3	18	$\mu\text{s}$	

- Current Conversion Ratio =  $I_C / I_F \times 100\%$

**7. Rank table of current transfer ratio CTR (tolerance:±3%)**

CTR Rank	Min.	Max.	Condition
A	80	160	$I_F=5mA, V_{CE}=5V, T_a=25^{\circ}C$
B	130	260	
C	200	400	
D	300	600	
No mark	50	600	

**8. Order Information**

**Part Number**

**OR-357X-W-Y-Z-(CG)**

**Note**

X = CTR Rank (A, B, C, D or none)  
W = Tape and reel option (TP or TP1).  
Y = 'V' code for VDE safety (This options is not necessary).  
Z = 'G' code for Halogen free .  
CG = Field Code.

\* VDE Code can be selected.

Option	Description	Packing quantity
TP	Surface mount lead form (low profile) + TP tape & reel option	3000 units per reel
TP1	Surface mount lead form (low profile) + TP1 tape & reel option	3000 units per reel

## 9. Naming Rule

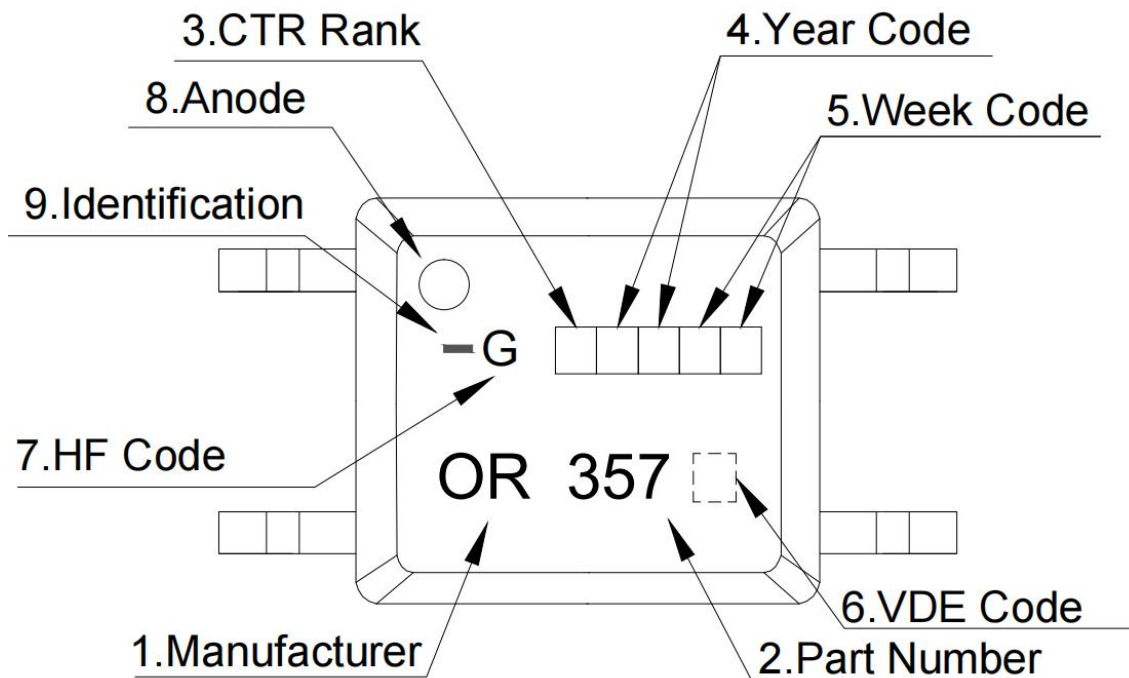

1. Manufacturer : ORIENT.
2. Part Number : 357.
3. Rank Code [ ]: CTR Rank
4. Year Code [ ][ ] : '0' means '2020' and so on.
5. Week Code [ ][ ]: 01 means the first week, 02 means the second week and so on.
6. VDE Code [ ] (Optional)
7. HF Code 'G': Halogen Free.
8. Anode.
9. Identification.

\* VDE Code can be selected.

### 10. Outer Dimension

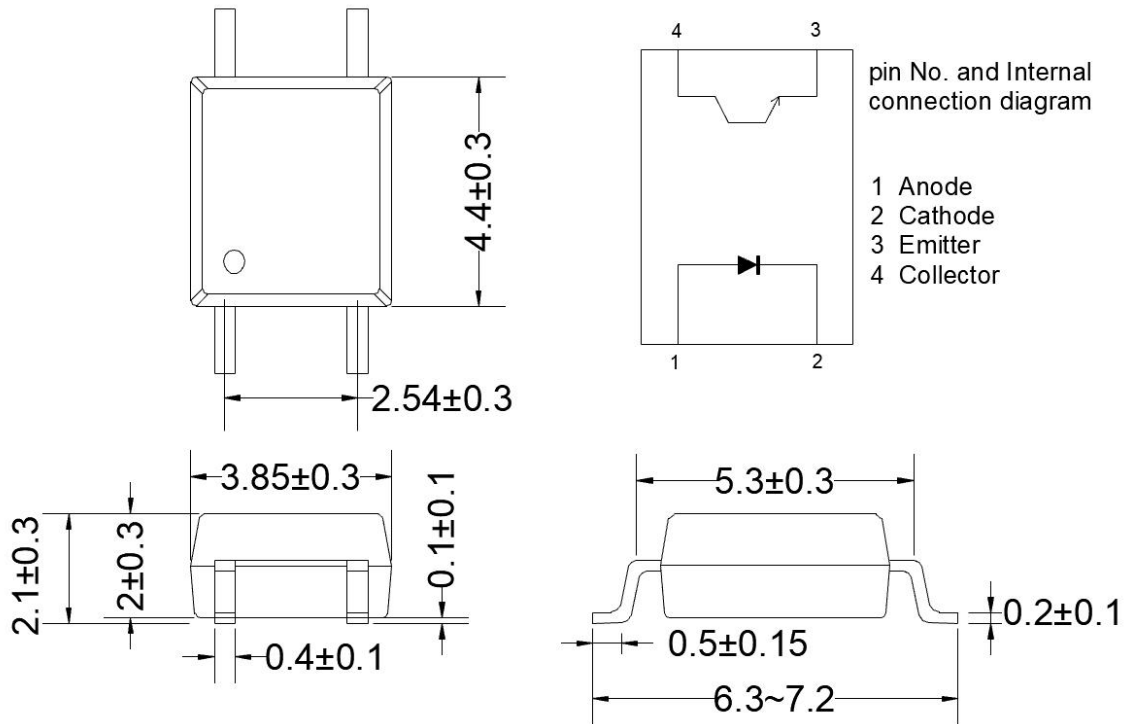

### 11. Recommended Foot Print Patterns (Mount Pad)

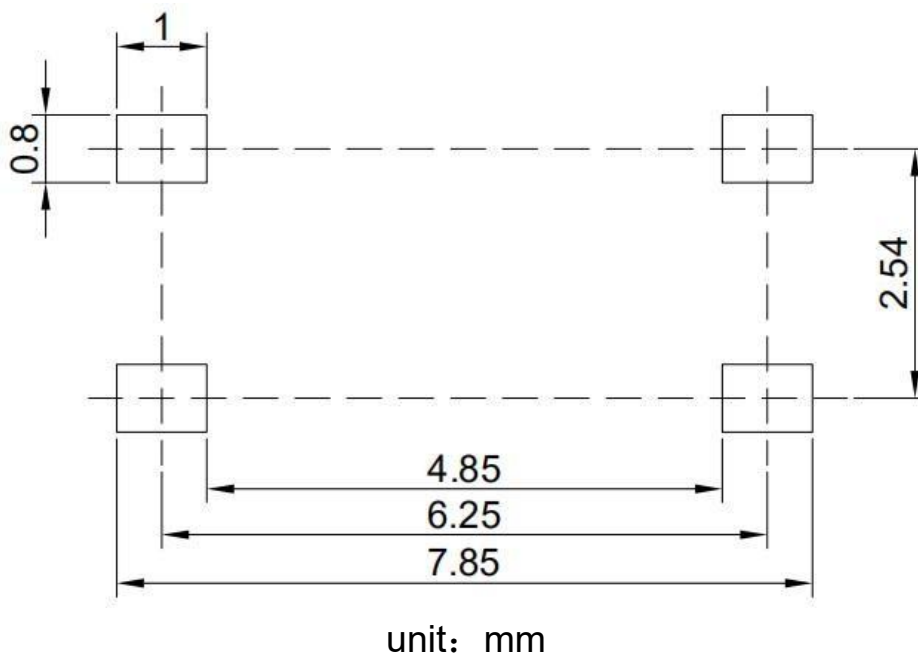

## 12. Taping Dimensions

### (1) OR-357-TP

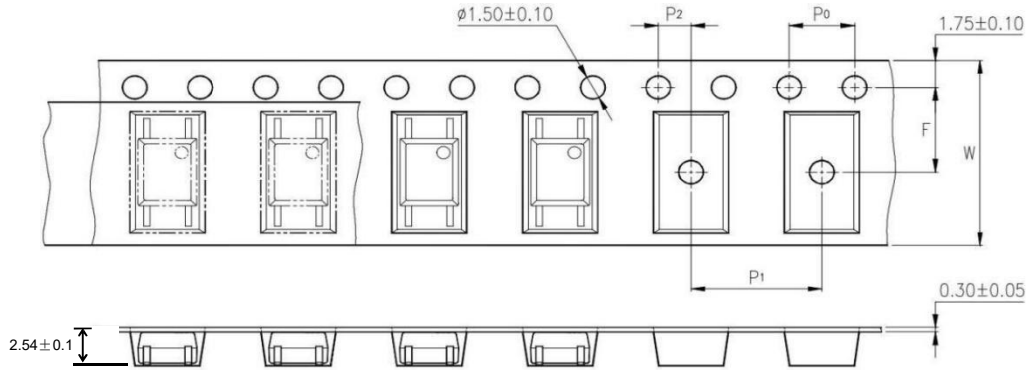

### (2) OR-357-TP1

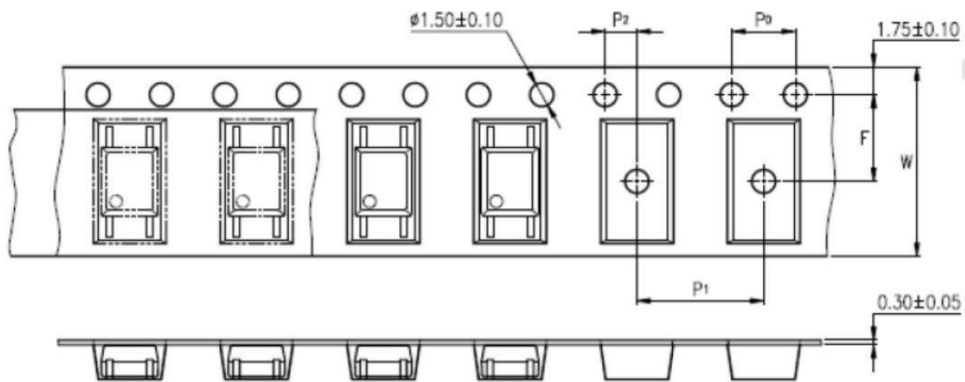

Description	Symbol	Dimension in mm(inch)
Tape wide	W	12±0.3 (0.472)
Pitch of sprocket holes	P0	4±0.1 (0.157)
Distance of compartment	F	5.5±0.1 (0.217)
	P2	2±0.1 (0.079)
Distance of compartment to compartment	P1	8±0.1 (0.315)

Package Type	TP/TP1
Quantities(pcs)	3000



### 13. Package Dimension

#### (1) package dimension

Packing Information	
Packing type	Reel type
Tape Width	12mm
Qty per Reel	3,000pcs
Small box (inner) Dimension	345*345*45mm
Large box (Outer) Dimension	480x360x360mm
Max qty per small box	6,000pcs
Max qty per large box	60,000pcs

#### (2)Packing Label Sample



**ORIENT**  
ShenZhen Orient  
Components Co.,LTD





Material Code : 120PCXXXXXX  
  
P/N : OR-XXXXXX  
  
Lot No. : XXXXXX-XXXX-TX-X  
  
D/C : XXXX  
  
Qty : XXXX PCS  

内箱码

外箱码

“XXXXXXXXXXXXXXXX” (一体机序列码)  
**Made in China**

**Note:**

1. Material Code :Product ID.
2. P/N :Contents with "Order Information" in the specification.
3. Lot No. :Product data.
4. D/C :Product weeks.
5. Quantity :Packaging quantity.

## 14. Reliability Test

NO.	ITEMS	Reliability Testing				
		QTY. (Pcs)	Condition	Process	Device	Standard
1	RSH 耐焊接热	22	260±5℃	10s/3 次	锡炉	JESD22-A106
2	HTSL 高温存储	77	125℃	168 hrs	高温烤箱 测试仪	JESD22-A103
				500 hrs		
				1000 hrs		
3	LTSL 低温存储	77	-55℃	168 hrs	低温箱 测试仪	JESD22-A119
				500 hrs		
				1000 hrs		
4	TC 温度循环	77	H:125℃ 15min ∫ 5min L:-55℃ 15min	300 cycle	冷热冲击机	JESD22-A104
5	TS 温度冲击	77	H:100℃ 5min ∫ 15s L:-40℃ 5min	300 cycle	冷热冲击机	JESD22-A106
6	HTOL 高温操作	77	110℃ IF=10mA Vce=5V	168 hrs	高温烤箱 测试仪、老 化电路板	JESD22-A108
				500 hrs		
				1000 hrs		
7	ESD-HBM 人体模式	22	≥8KV 1Cycle	1次	ESD静电测 试仪	JESD22-A114
8	SD 可焊性	22	Pb-free 245±5℃	5S/1次	锡炉	JESD22-B102
9	HTRB 高温反向偏压	77	HTRB @125℃ Vce=80v	168 hrs	高温烤箱 , 测试仪	JESD22-A103
				500 hrs		
				1000 hrs		
10	H3TRB 温湿度反向偏 压, 寿命试验	77	H3TRB 85℃,85%RH Vce=80v	168 hrs	恒温恒湿 机, 测试仪	JESD22-A101
				500 hrs		
				1000 hrs		
11	Autoclave 压力锅	77	Ta=121 ℃,100%RH,2atm	96hrs	压力锅	JESD22-A102

### 15. Temperature Profile Of Soldering

(1) IR Reflow soldering (JEDEC-STD-020C compliant)

One time soldering reflow is recommended within the condition of temperature and time profile shown below. Do not solder more than three times.

Profile item	Conditions
Preheat	
- Temperature Min (T Smin )	150°C
- Temperature Max (T Smax )	200°C
- Time (min to max) (ts)	90±30 sec
Soldering zone	
- Temperature (TL )	217°C
- Time (t L )	60 sec
Peak Temperature	260°C
Peak Temperature time	20 sec
Ramp-up rate	3°C / sec max.
Ramp-down rate from peak temperature	3~6°C / sec
Reflow times	≤3

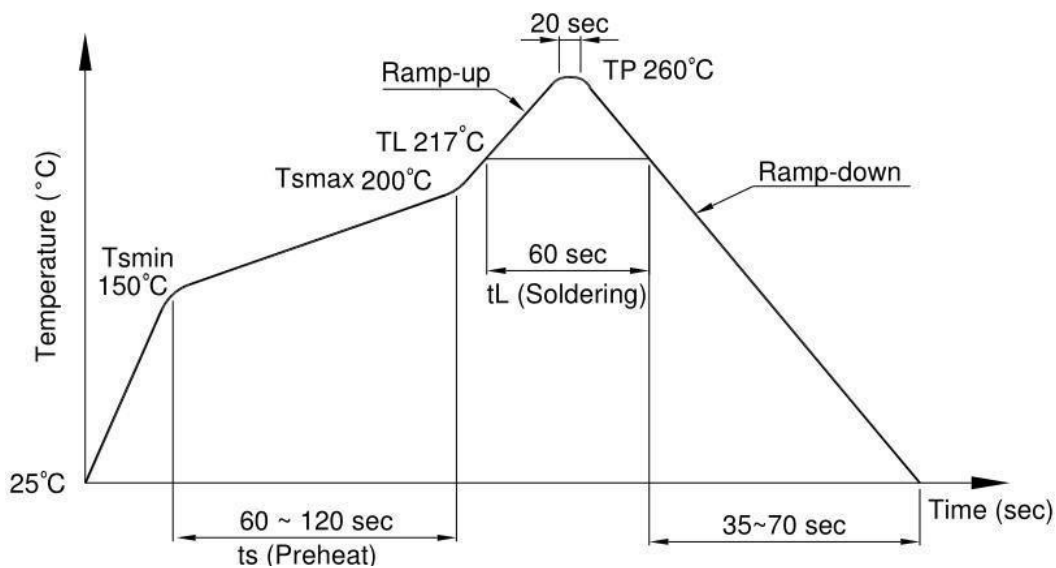

(2) Wave soldering (JEDEC22A111 compliant)

One time soldering is recommended within the condition of temperature.

Temperature	260+0/-5°C
Time	10 sec
Preheat temperature	25 to 140°C
Preheat time	30 to 80 sec

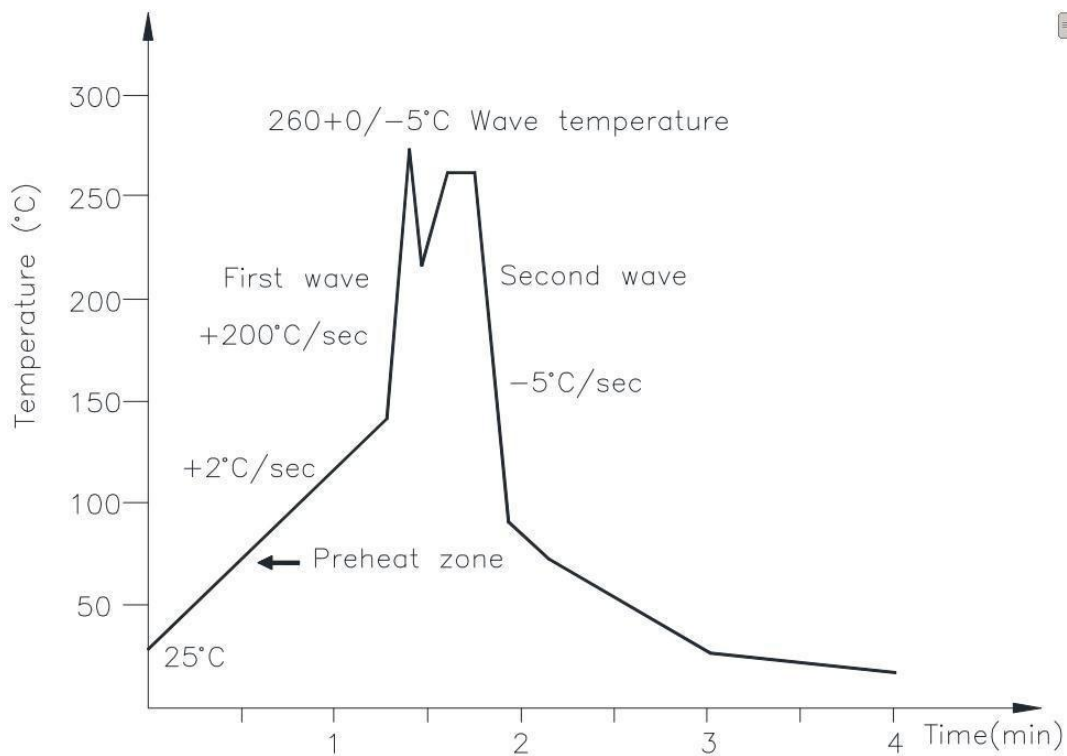

(3) Hand soldering by soldering iron

Allow single lead soldering in every single process. One time soldering is recommended.

Temperature	380+0/-5°C
Time	3 sec max

## 16. Characteristics Curves

Fig.1 Forward current vs Ambient temperature

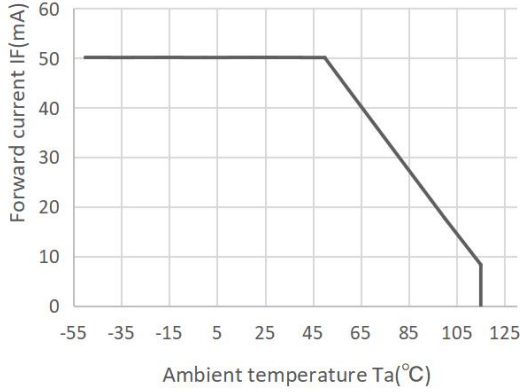

Fig.2 Collector Power Dissipation vs. Ambient temperature

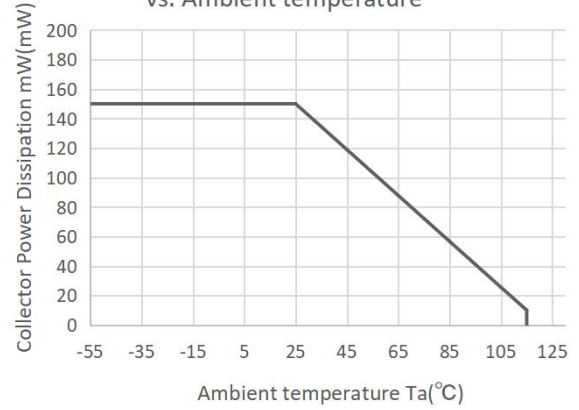

Fig.3 Collector-emitter Saturation Voltage vs. Forward Current

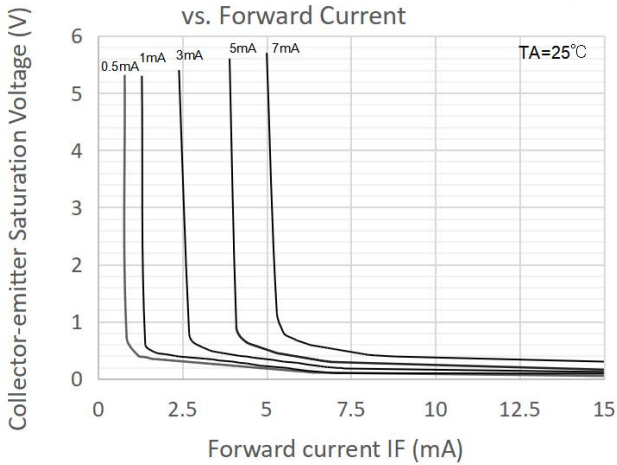

Fig.4 Forward Current vs. Forward Voltage

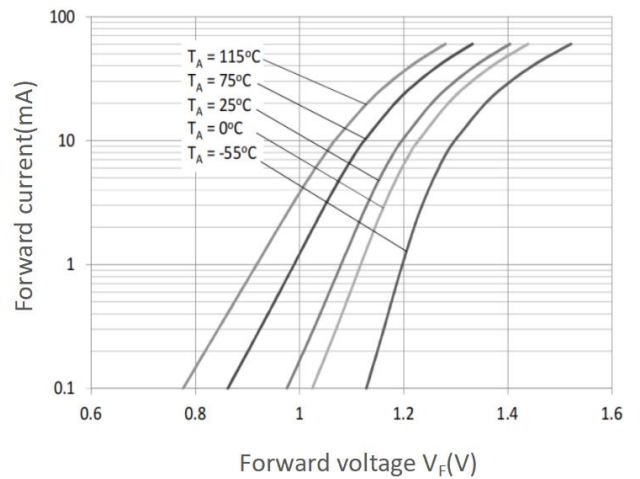

Fig.5 Forward Current vs. Current Transfer Ratio

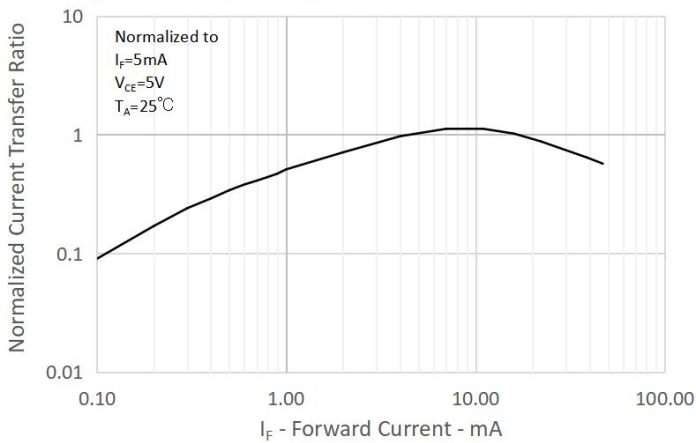

Fig.6 Collector Current vs. Collector-emitter Voltage

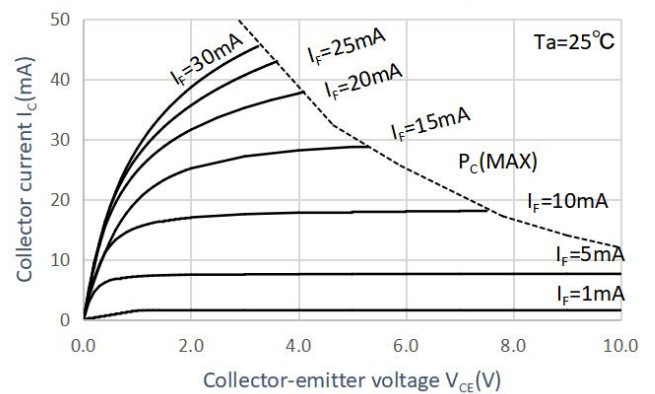

Fig.7 Relative Current Transfer Ratio vs. Ambient Temperature

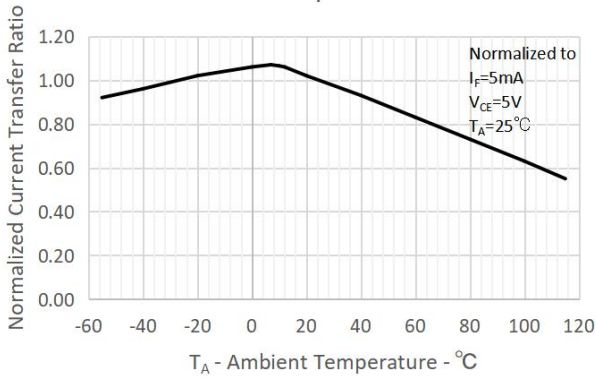

Fig.8 Collector-emitter Saturation Voltage vs. Ambient Temperature

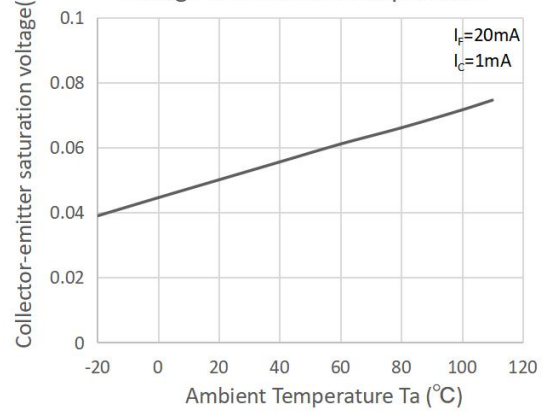

Fig.9 Collector Dark Current vs. Ambient Temperature

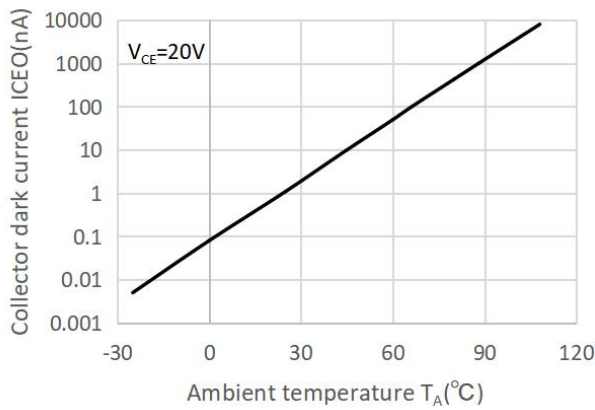

Fig.10 Respinse Time vs. Load Resistance

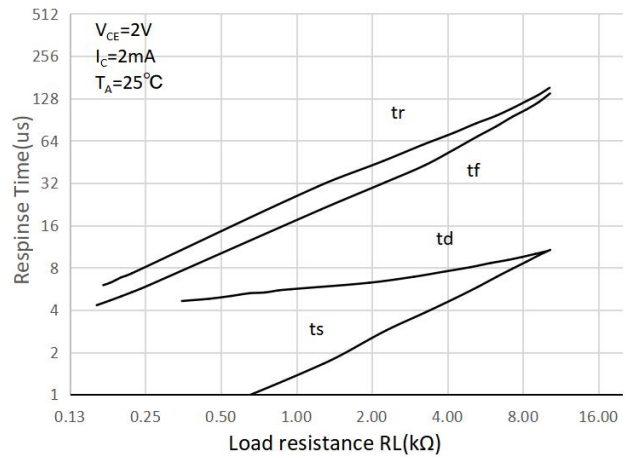
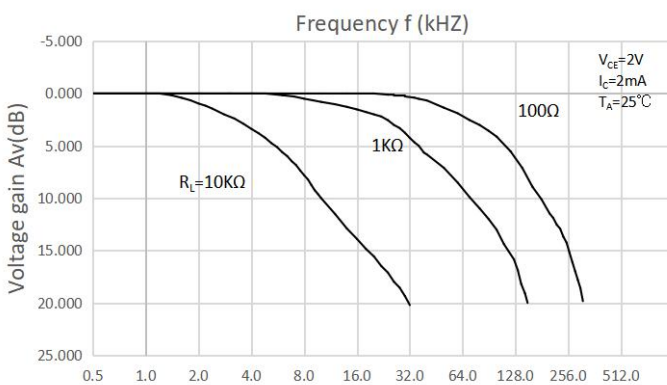
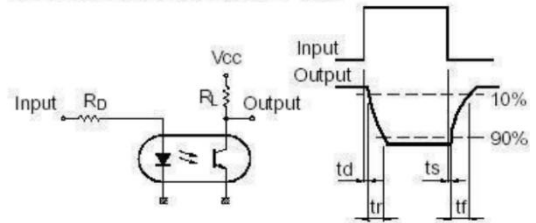

Fig.11 Frequency Response



Test Circuit for Response Time



Test Circuit for Frequency Response

